

Multilin™ EPM 2200 Power Meter



Instruction Manual

Software Revision: 1.0x
Manual P/N: 1601- 9111-A5
Manual Order Code: GEK-113575D



Copyright © 2016 GE Multilin Inc. All rights reserved.

EPM 2200 Power Meter Instruction Manual for product revision 1.0x.

The contents of this manual are the property of GE Multilin Inc. This documentation is furnished on license and may not be reproduced in whole or in part without the permission of GE Multilin. The manual is for informational use only and is subject to change without notice.

Part number: 1601-9111-A5 (June 2016)



GENERAL SAFETY PRECAUTIONS - EPM 2200

- Failure to observe and follow the instructions provided in the equipment manual(s) could cause irreversible damage to the equipment and could lead to property damage, personal injury and/or death.
- Before attempting to use the equipment, it is important that all danger and caution indicators are reviewed.
- If the equipment is used in a manner not specified by the manufacturer or functions abnormally, proceed with caution. Otherwise, the protection provided by the equipment may be impaired and can result in Impaired operation and injury.
- Caution: Hazardous voltages can cause shock, burns or death.
- Installation/service personnel must be familiar with general device test practices, electrical awareness and safety precautions must be followed.
- Before performing visual inspections, tests, or periodic maintenance on this device or associated circuits, isolate or disconnect all hazardous live circuits and sources of electric power.
- Failure to shut equipment off prior to removing the power connections could expose you to dangerous voltages causing injury or death.
- All recommended equipment that should be grounded and must have a reliable and un-compromised grounding path for safety purposes, protection against electromagnetic interference and proper device operation.
- Equipment grounds should be bonded together and connected to the facility's main ground system for primary power.
- Keep all ground leads as short as possible.
- At all times, equipment ground terminal must be grounded during device operation and service.
- In addition to the safety precautions mentioned all electrical connections made must respect the applicable local jurisdiction electrical code.
- Before working on CTs, they must be short-circuited.
- To be certified for revenue metering, power providers and utility companies must verify that the billing energy meter performs to the stated accuracy. To confirm the meter's performance and calibration, power providers use field test standards to ensure that the unit's energy measurements are correct.

This product cannot be disposed of as unsorted municipal waste in the European Union. For proper recycling return this product to your supplier or a designated collection point. For more information go to www.recyclethis.info.

Safety words and definitions

The following symbols used in this document indicate the following conditions



Indicates a hazardous situation which, if not avoided, will result in death or serious injury.



Indicates a hazardous situation which, if not avoided, could result in death or serious injury.



Indicates a hazardous situation which, if not avoided, could result in minor or moderate injury.



Indicates practices not related to personal injury.



Indicates general information and practices, including operational information, that are not related to personal injury.

For further assistance

For product support, contact the information and call center as follows:

GE Solutions
650 Markland Street
Markham, Ontario
Canada L6C 0M1
Worldwide telephone: +1 905 927 7070
Europe/Middle East/Africa telephone: +34 94 485 88 54
North America toll-free: 1 800 547 8629
Fax: +1 905 927 5098
Worldwide e-mail: multilin.tech@ge.com
Europe e-mail: multilin.tech.euro@ge.com
Website: <http://www.gegridsolutions.com/multilin>

Warranty

For products shipped as of 1 October 2013, GE warrants most of its GE manufactured products for 10 years. For warranty details including any limitations and disclaimers, see our Terms and Conditions at <https://www.gegridsolutions.com/multilin/warranty.htm>

For products shipped before 1 October 2013, the standard 24-month warranty applies.

Table of Contents

1: THREE-PHASE POWER MEASUREMENT	THREE PHASE SYSTEM CONFIGURATIONS	1-1
	WYE CONNECTION	1-1
	DELTA CONNECTION	1-3
	BLONDEL'S THEOREM AND THREE PHASE MEASUREMENT	1-4
	POWER, ENERGY AND DEMAND	1-6
	REACTIVE ENERGY AND POWER FACTOR	1-9
	HARMONIC DISTORTION	1-11
	POWER QUALITY	1-13

2: OVERVIEW AND SPECIFICATIONS	HARDWARE OVERVIEW	2-1
	VOLTAGE AND CURRENT INPUTS	2-2
	ORDER CODES	2-2
	MEASURED VALUES	2-3
	UTILITY PEAK DEMAND	2-3
	SPECIFICATIONS	2-4
	COMPLIANCE	2-8
	ACCURACY	2-9

3: MECHANICAL INSTALLATION	INTRODUCTION	3-1
	ANSI INSTALLATION STEPS	3-2
	DIN INSTALLATION STEPS	3-3

4: ELECTRICAL INSTALLATION	CONSIDERATIONS WHEN INSTALLING METERS	4-1
	CT LEADS TERMINATED TO METER	4-2
	CT LEADS PASS-THROUGH (NO METER TERMINATION)	4-3
	QUICK CONNECT CRIMP CT TERMINATIONS	4-5
	VOLTAGE AND POWER SUPPLY CONNECTIONS	4-6
	GROUND CONNECTIONS	4-6
	VOLTAGE FUSES	4-6
	ELECTRICAL CONNECTION DIAGRAMS	4-7
	DESCRIPTION	4-7
	(1) WYE, 4-WIRE WITH NO PTs AND 3 CTs, NO PTs, 3 ELEMENT	4-8
	(2) WYE, 4-WIRE WITH NO PTs AND 3 CTs, 2.5 ELEMENT	4-11
	(3) WYE, 4-WIRE WITH 3 PTs AND 3 CTs, 3 ELEMENT	4-12
	(4) WYE, 4-WIRE WITH 2 PTs AND 3 CTs, 2.5 ELEMENT	4-13
	(5) DELTA, 3-WIRE WITH NO PTs, 2 CTs	4-14
(6) DELTA, 3-WIRE WITH 2 PTs, 2 CTs	4-15	
(7) DELTA, 3-WIRE WITH 2 PTs, 3 CTs	4-16	
(8) CURRENT-ONLY MEASUREMENT (THREE-PHASE)	4-17	
(9) CURRENT-ONLY MEASUREMENT (DUAL-PHASE)	4-18	
(10) CURRENT-ONLY MEASUREMENT (SINGLE-PHASE)	4-19	

5: COM OPTION S: MODBUS/KYZ OUTPUT	CONNECTING TO THE RS485/KYZ OUTPUT PORT	5-1
---	---	-----

6: USING THE METER	PROGRAMMING USING THE FACEPLATE	6-1
	METER FACE ELEMENTS	6-2
	METER FACE BUTTONS	6-2
	START UP	6-3
	MAIN MENU	6-4
	RESET MODE	6-4
	ENTER PASSWORD (IF ENABLED)	6-5
	CONFIGURATION MODE	6-6
	CONFIGURING THE SCROLL FEATURE	6-8
	CONFIGURING THE CT SETTING	6-9
	CONFIGURING THE PT SETTING	6-10
	CONFIGURING THE CONNECTION (CNCT) SETTING	6-11
	CONFIGURING THE COMMUNICATION PORT SETTINGS	6-12
	OPERATING MODE	6-14
	% OF LOAD BAR	6-15
	WATT-HOUR ACCURACY TESTING (VERIFICATION)	6-15
	INFRARED & KYZ PULSE CONSTANTS FOR ACCURACY TESTING	6-16
	GE COMMUNICATOR PROGRAMMING OVERVIEW	6-17
	FACTORY INITIAL DEFAULT SETTINGS	6-17
	HOW TO CONNECT USING GE COMMUNICATOR SOFTWARE	6-17
	DEVICE PROFILE SETTINGS	6-20

7: COM OPTION B: BACNET MS/TP WITH MODBUS TCP/IP	BACNET MS/TP	7-1
	EPM 2200 METER BACNET OBJECTS	7-2
	CONFIGURING COM OPTION B: BACNET MS/TP WITH MODBUS TCP/IP	7-4
	RESETTING THE ETHERNET CARD	7-11
	USING THE EPM 2200 METER'S WEB INTERFACE	7-11
	HOME WEB PAGE	7-11
	BACNET OBJECTS STATUS WEB PAGE	7-13
	CHANGE PASSWORD WEB PAGE	7-14
	STATISTICS WEB PAGE	7-14
	RESET CONFIGURATION WEB PAGE	7-15
	USING THE EPM 2200 IN A BACNET APPLICATION	7-15

A: EPM 2200 NAVIGATION MAPS	INTRODUCTION	A-1
	NAVIGATION MAPS (SHEETS 1 TO 4)	A-1
	EPM 2200 NAVIGATION MAP TITLES:	A-1

B: MODBUS MAPPING FOR EPM 2200	INTRODUCTION	B-1
	MODBUS REGISTER MAP SECTIONS	B-1
	DATA FORMATS	B-2
	FLOATING POINT VALUES	B-2
	MODBUS REGISTER MAP	B-3

C: MANUAL REVISION HISTORY	RELEASE NOTES	C-1
---------------------------------------	----------------------------	-----

EPM 2200 Power Meter

Chapter 1: Three-Phase Power Measurement

This introduction to three-phase power and power measurement is intended to provide only a brief overview of the subject. The professional meter engineer or meter technician should refer to more advanced documents such as the EEI Handbook for Electricity Metering and the application standards for more in-depth and technical coverage of the subject.

1.1 Three Phase System Configurations

Three-phase power is most commonly used in situations where large amounts of power will be used because it is a more effective way to transmit the power and because it provides a smoother delivery of power to the end load. There are two commonly used connections for three-phase power, a wye connection or a delta connection. Each connection has several different manifestations in actual use.

When attempting to determine the type of connection in use, it is a good practice to follow the circuit back to the transformer that is serving the circuit. It is often not possible to conclusively determine the correct circuit connection simply by counting the wires in the service or checking voltages. Checking the transformer connection will provide conclusive evidence of the circuit connection and the relationships between the phase voltages and ground.

1.2 Wye Connection

The wye connection is so called because when you look at the phase relationships and the winding relationships between the phases it looks like a Y. Figure 1.1 depicts the winding relationships for a wye-connected service. In a wye service the neutral (or center point of the wye) is typically grounded. This leads to common voltages of 208/120 and 480/277 (where the first number represents the phase-to-phase voltage and the second number represents the phase-to-ground voltage).

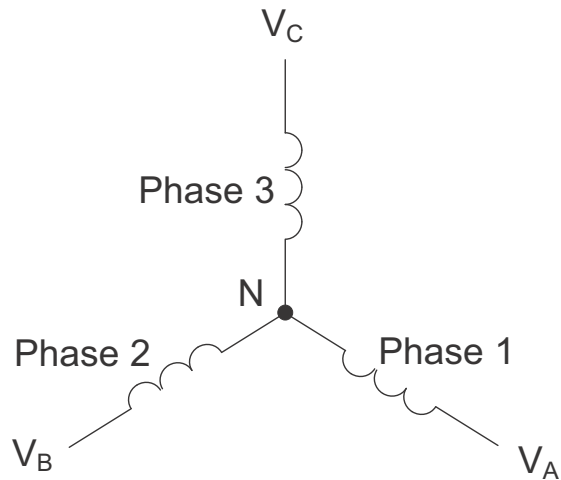

Figure 1-1: Three-phase Wye Winding

The three voltages are separated by 120° electrically. Under balanced load conditions the currents are also separated by 120° . However, unbalanced loads and other conditions can cause the currents to depart from the ideal 120° separation. Three-phase voltages and currents are usually represented with a phasor diagram. A phasor diagram for the typical connected voltages and currents is shown in Figure 1.2.

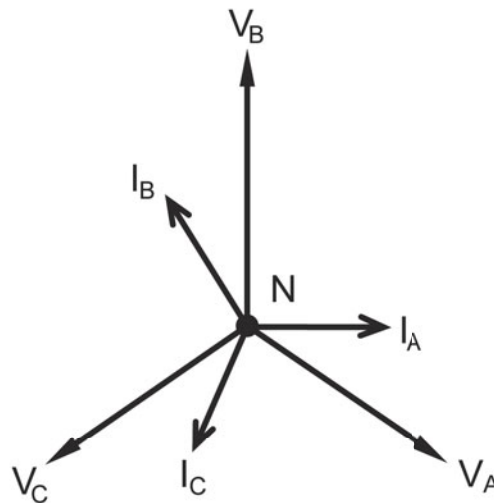

Figure 1-2: Phasor Diagram Showing Three-phase Voltages and Currents

The phasor diagram shows the 120° angular separation between the phase voltages. The phase-to-phase voltage in a balanced three-phase wye system is 1.732 times the phase-to-neutral voltage. The center point of the wye is tied together and is typically grounded. Table 1.1 shows the common voltages used in the United States for wye-connected systems.

Table 1.1: Common Phase Voltages on Wye Services

Phase to Ground Voltage	Phase to Phase Voltage
120 volts	208 volts
277 volts	480 volts
2,400 volts	4,160 volts
7,200 volts	12,470 volts

Table 1.1: Common Phase Voltages on Wye Services

Phase to Ground Voltage	Phase to Phase Voltage
7,620 volts	13,200 volts

Usually a wye-connected service will have four wires: three wires for the phases and one for the neutral. The three-phase wires connect to the three phases (as shown in Figure 1.1). The neutral wire is typically tied to the ground or center point of the wye.

In many industrial applications the facility will be fed with a four-wire wye service but only three wires will be run to individual loads. The load is then often referred to as a delta-connected load but the service to the facility is still a wye service; it contains four wires if you trace the circuit back to its source (usually a transformer). In this type of connection the phase to ground voltage will be the phase-to-ground voltage indicated in Table 1, even though a neutral or ground wire is not physically present at the load. The transformer is the best place to determine the circuit connection type because this is a location where the voltage reference to ground can be conclusively identified.

1.3 Delta Connection

Delta-connected services may be fed with either three wires or four wires. In a three-phase delta service the load windings are connected from phase-to-phase rather than from phase-to-ground. Figure 1.3 shows the physical load connections for a delta service.

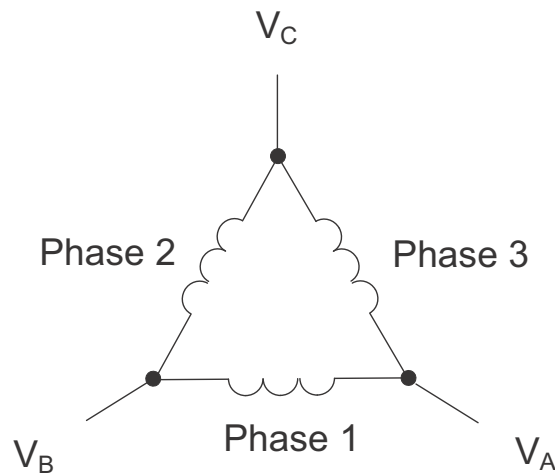
**Figure 1-3: Three-phase Delta Winding Relationship**

In this example of a delta service, three wires will transmit the power to the load. In a true delta service, the phase-to-ground voltage will usually not be balanced because the ground is not at the center of the delta.

Figure 1.4 shows the phasor relationships between voltage and current on a three-phase delta circuit.

In many delta services, one corner of the delta is grounded. This means the phase to ground voltage will be zero for one phase and will be full phase-to-phase voltage for the other two phases. This is done for protective purposes.

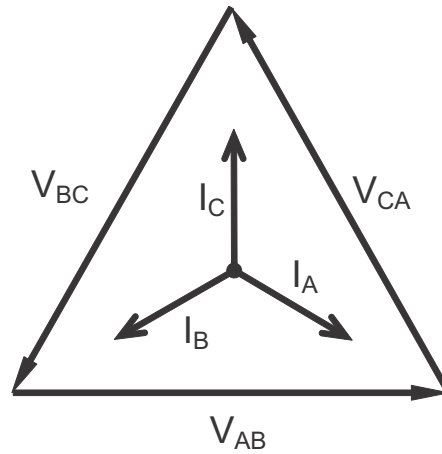

Figure 1-4: Phasor Diagram, Three-Phase Voltages and Currents, Delta-Connected

Another common delta connection is the four-wire, grounded delta used for lighting loads. In this connection the center point of one winding is grounded. On a 120/240 volt, four-wire, grounded delta service the phase-to-ground voltage would be 120 volts on two phases and 208 volts on the third phase. Figure 1.5 shows the phasor diagram for the voltages in a three-phase, four-wire delta system.

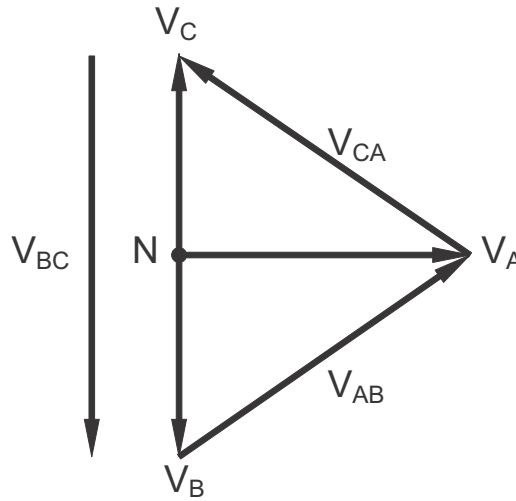

Figure 1-5: Phasor Diagram Showing Three-phase Four-Wire Delta-Connected System

1.4 Blondel's Theorem and Three Phase Measurement

In 1893 an engineer and mathematician named Andre E. Blondel set forth the first scientific basis for polyphase metering. His theorem states:

If energy is supplied to any system of conductors through N wires, the total power in the system is given by the algebraic sum of the readings of N wattmeters so arranged that each of the N wires contains one current coil, the corresponding potential coil being connected between that wire and some common point. If this common point is on one of the N wires, the measurement may be made by the use of N-1 Wattmeters.

The theorem may be stated more simply, in modern language:

In a system of N conductors, N-1 meter elements will measure the power or energy taken provided that all the potential coils have a common tie to the conductor in which there is no current coil.

Three-phase power measurement is accomplished by measuring the three individual phases and adding them together to obtain the total three phase value. In older analog meters, this measurement was accomplished using up to three separate elements. Each element combined the single-phase voltage and current to produce a torque on the meter disk. All three elements were arranged around the disk so that the disk was subjected to the combined torque of the three elements. As a result the disk would turn at a higher speed and register power supplied by each of the three wires.

According to Blondel's Theorem, it was possible to reduce the number of elements under certain conditions. For example, a three-phase, three-wire delta system could be correctly measured with two elements (two potential coils and two current coils) if the potential coils were connected between the three phases with one phase in common.

In a three-phase, four-wire wye system it is necessary to use three elements. Three voltage coils are connected between the three phases and the common neutral conductor. A current coil is required in each of the three phases.

In modern digital meters, Blondel's Theorem is still applied to obtain proper metering. The difference in modern meters is that the digital meter measures each phase voltage and current and calculates the single-phase power for each phase. The meter then sums the three phase powers to a single three-phase reading.

Some digital meters measure the individual phase power values one phase at a time. This means the meter samples the voltage and current on one phase and calculates a power value. Then it samples the second phase and calculates the power for the second phase. Finally, it samples the third phase and calculates that phase power. After sampling all three phases, the meter adds the three readings to create the equivalent three-phase power value. Using mathematical averaging techniques, this method can derive a quite accurate measurement of three-phase power.

More advanced meters actually sample all three phases of voltage and current simultaneously and calculate the individual phase and three-phase power values. The advantage of simultaneous sampling is the reduction of error introduced due to the difference in time when the samples were taken.

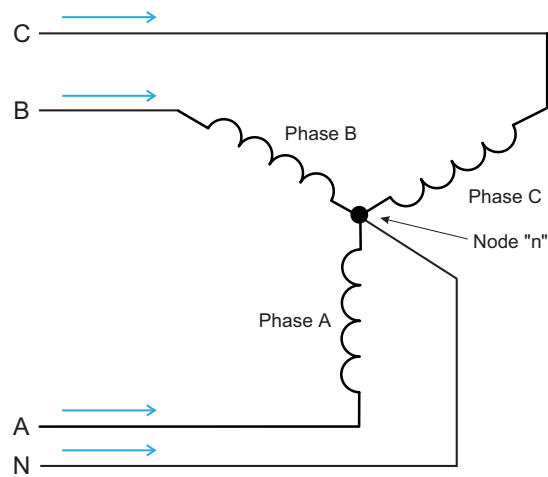

Figure 1-6: Three-Phase Wye Load Illustrating Kirchoff's Law and Blondel's Theorem

Blondel's Theorem is a derivation that results from Kirchoff's Law. Kirchoff's Law states that the sum of the currents into a node is zero. Another way of stating the same thing is that the current into a node (connection point) must equal the current out of the node. The law can be applied to measuring three-phase loads. Figure 1.6 shows a typical connection of a three-phase load applied to a three-phase, four-wire service. Kirchoff's Law holds that the sum of currents A, B, C and N must equal zero or that the sum of currents into Node "n" must equal zero.

If we measure the currents in wires A, B and C, we then know the current in wire N by Kirchoff's Law and it is not necessary to measure it. This fact leads us to the conclusion of Blondel's Theorem- that we only need to measure the power in three of the four wires if they are connected by a common node. In the circuit of Figure 1.6 we must measure the power flow in three wires. This will require three voltage coils and three current coils (a three-element meter). Similar figures and conclusions could be reached for other circuit configurations involving Delta-connected loads.

1.5 Power, Energy and Demand

It is quite common to exchange power, energy and demand without differentiating between the three. Because this practice can lead to confusion, the differences between these three measurements will be discussed.

Power is an instantaneous reading. The power reading provided by a meter is the present flow of watts. Power is measured immediately just like current. In many digital meters, the power value is actually measured and calculated over a one second interval because it takes some amount of time to calculate the RMS values of voltage and current. But this time interval is kept small to preserve the instantaneous nature of power.

Energy is always based on some time increment; it is the integration of power over a defined time increment. Energy is an important value because almost all electric bills are based, in part, on the amount of energy used.

Typically, electrical energy is measured in units of kilowatt-hours (kWh). A kilowatt-hour represents a constant load of one thousand watts (one kilowatt) for one hour. Stated another way, if the power delivered (instantaneous watts) is measured as 1,000 watts and the load was served for a one hour time interval then the load would have absorbed one kilowatt-hour of energy. A different load may have a constant power requirement of 4,000 watts. If the load were served for one hour it would absorb four kWh. If the load were served for 15 minutes it would absorb $\frac{1}{4}$ of that total or one kWh.

Figure 1.7 shows a graph of power and the resulting energy that would be transmitted as a result of the illustrated power values. For this illustration, it is assumed that the power level is held constant for each minute when a measurement is taken. Each bar in the graph will represent the power load for the one-minute increment of time. In real life the power value moves almost constantly.

The data from Figure 1.7 is reproduced in Table 1.2 to illustrate the calculation of energy. Since the time increment of the measurement is one minute and since we specified that the load is constant over that minute, we can convert the power reading to an equivalent consumed energy reading by multiplying the power reading times $1/60$ (converting the time base from minutes to hours).

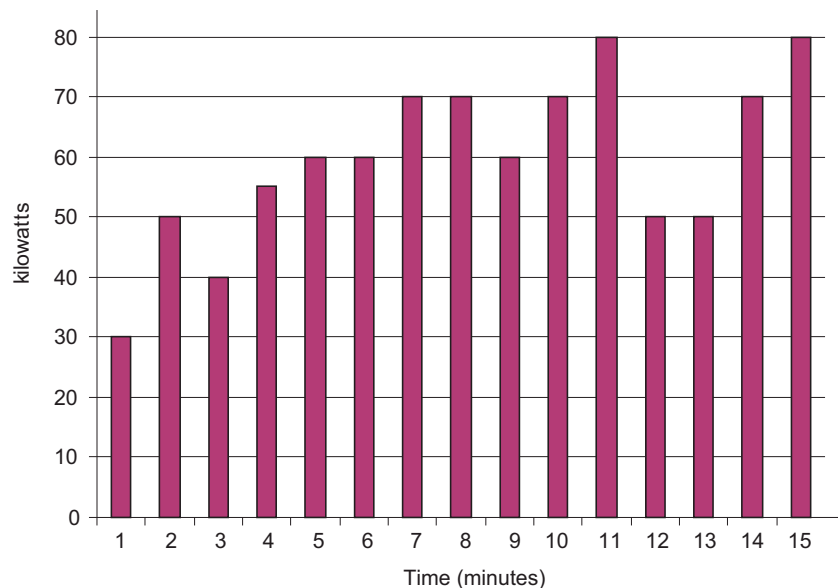

Figure 1-7: Power Use over Time

Table 1.2: Power and Energy Relationship over Time

Time Interval (minute)	Power (kW)	Energy (kWh)	Accumulated Energy (kWh)
1	30	0.50	0.50
2	50	0.83	1.33
3	40	0.67	2.00
4	55	0.92	2.92
5	60	1.00	3.92
6	60	1.00	4.92

Table 1.2: Power and Energy Relationship over Time

Time Interval (minute)	Power (kW)	Energy (kWh)	Accumulated Energy (kWh)
7	70	1.17	6.09
8	70	1.17	7.26
9	60	1.00	8.26
10	70	1.17	9.43
11	80	1.33	10.76
12	50	0.83	12.42
13	50	0.83	12.42
14	70	1.17	13.59
15	80	1.33	14.92

As in Table 1.2, the accumulated energy for the power load profile of Figure 1.7 is 14.92 kWh.

Demand is also a time-based value. The demand is the average rate of energy use over time. The actual label for demand is kilowatt-hours/hour but this is normally reduced to kilowatts. This makes it easy to confuse demand with power, but demand is not an instantaneous value. To calculate demand it is necessary to accumulate the energy readings (as illustrated in Figure 1.7) and adjust the energy reading to an hourly value that constitutes the demand.

In the example, the accumulated energy is 14.92 kWh. But this measurement was made over a 15-minute interval. To convert the reading to a demand value, it must be normalized to a 60-minute interval. If the pattern were repeated for an additional three 15-minute intervals the total energy would be four times the measured value or 59.68 kWh. The same process is applied to calculate the 15-minute demand value. The demand value associated with the example load is 59.68 kWh/hr or 59.68 kWd. Note that the peak instantaneous value of power is 80 kW, significantly more than the demand value.

Figure 1.8 shows another example of energy and demand. In this case, each bar represents the energy consumed in a 15-minute interval. The energy use in each interval typically falls between 50 and 70 kWh. However, during two intervals the energy rises sharply and peaks at 100 kWh in interval number 7. This peak of usage will result in setting a high demand reading. For each interval shown the demand value would be four times the indicated energy reading. So interval 1 would have an associated demand of 240 kWh/hr. Interval 7 will have a demand value of 400 kWh/hr. In the data shown, this is the peak demand value and would be the number that would set the demand charge on the utility bill.

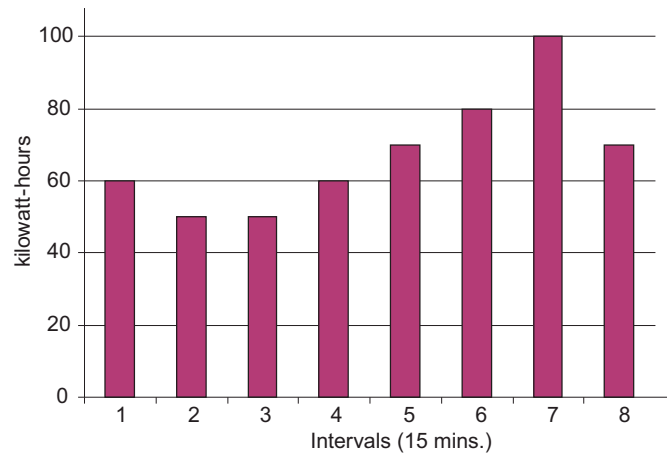

Figure 1-8: Energy Use and Demand

As can be seen from this example, it is important to recognize the relationships between power, energy and demand in order to control loads effectively or to monitor use correctly.

1.6 Reactive Energy and Power Factor

The real power and energy measurements discussed in the previous section relate to the quantities that are most used in electrical systems. But it is often not sufficient to only measure real power and energy. Reactive power is a critical component of the total power picture because almost all real-life applications have an impact on reactive power. Reactive power and power factor concepts relate to both load and generation applications. However, this discussion will be limited to analysis of reactive power and power factor as they relate to loads. To simplify the discussion, generation will not be considered.

Real power (and energy) is the component of power that is the combination of the voltage and the value of corresponding current that is directly in phase with the voltage. However, in actual practice the total current is almost never in phase with the voltage. Since the current is not in phase with the voltage, it is necessary to consider both the inphase component and the component that is at quadrature (angularly rotated 90° or perpendicular) to the voltage. Figure 1.9 shows a single-phase voltage and current and breaks the current into its in-phase and quadrature components.

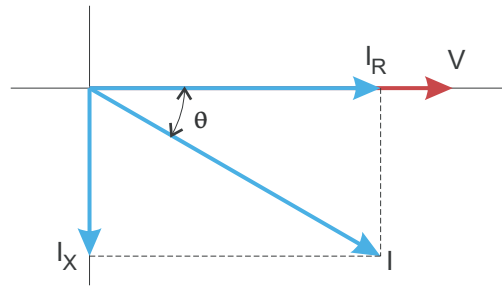

Figure 1-9: Voltage and Complex Current

The voltage (V) and the total current (I) can be combined to calculate the apparent power or VA. The voltage and the in-phase current (IR) are combined to produce the real power or watts. The voltage and the quadrature current (IX) are combined to calculate the reactive power.

The quadrature current may be lagging the voltage (as shown in Figure 1.9) or it may lead the voltage. When the quadrature current lags the voltage the load is requiring both real power (watts) and reactive power (VARs). When the quadrature current leads the voltage the load is requiring real power (watts) but is delivering reactive power (VARs) back into the system; that is VARs are flowing in the opposite direction of the real power flow.

Reactive power (VARs) is required in all power systems. Any equipment that uses magnetization to operate requires VARs. Usually the magnitude of VARs is relatively low compared to the real power quantities. Utilities have an interest in maintaining VAR requirements at the customer to a low value in order to maximize the return on plant invested to deliver energy. When lines are carrying VARs, they cannot carry as many watts. So keeping the VAR content low allows a line to carry its full capacity of watts. In order to encourage customers to keep VAR requirements low, some utilities impose a penalty if the VAR content of the load rises above a specified value.

A common method of measuring reactive power requirements is power factor. Power factor can be defined in two different ways. The more common method of calculating power factor is the ratio of the real power to the apparent power. This relationship is expressed in the following formula:

$$\text{Total PF} = \text{real power} / \text{apparent power} = \text{watts/VA}$$

This formula calculates a power factor quantity known as Total Power Factor. It is called Total PF because it is based on the ratios of the power delivered. The delivered power quantities will include the impacts of any existing harmonic content. If the voltage or current includes high levels of harmonic distortion the power values will be affected. By calculating power factor from the power values, the power factor will include the impact of harmonic distortion. In many cases this is the preferred method of calculation because the entire impact of the actual voltage and current are included.

A second type of power factor is Displacement Power Factor. Displacement PF is based on the angular relationship between the voltage and current. Displacement power factor does not consider the magnitudes of voltage, current or power. It is solely based on the phase angle differences. As a result, it does not include the impact of harmonic distortion. Displacement power factor is calculated using the following equation:

$$\text{Displacement PF} = \cos\theta$$

where θ is the angle between the voltage and the current (see Fig. 1.9).

In applications where the voltage and current are not distorted, the Total Power Factor will equal the Displacement Power Factor. But if harmonic distortion is present, the two power factors will not be equal.

1.7 Harmonic Distortion

Harmonic distortion is primarily the result of high concentrations of non-linear loads. Devices such as computer power supplies, variable speed drives and fluorescent light ballasts make current demands that do not match the sinusoidal waveform of AC electricity. As a result, the current waveform feeding these loads is periodic but not sinusoidal. Figure 1.10 shows a normal, sinusoidal current waveform. This example has no distortion.

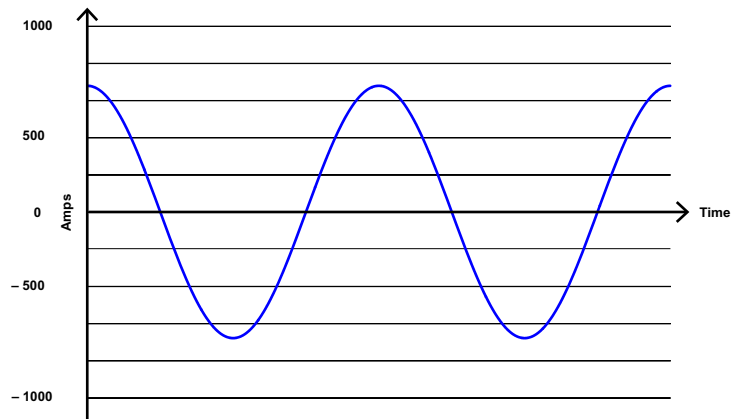

Figure 1-10: Nondistorted Current Waveform

Figure 1.11 shows a current waveform with a slight amount of harmonic distortion. The waveform is still periodic and is fluctuating at the normal 60 Hz frequency. However, the waveform is not a smooth sinusoidal form as seen in Figure 1.10.

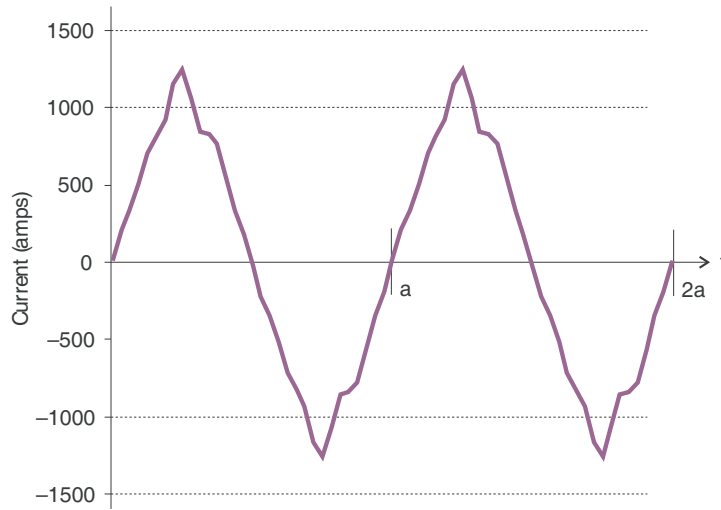

Figure 1-11: Distorted Current Waveform

The distortion observed in Figure 1.11 can be modeled as the sum of several sinusoidal waveforms of frequencies that are multiples of the fundamental 60 Hz frequency. This modeling is performed by mathematically disassembling the distorted waveform into a collection of higher frequency waveforms.

These higher frequency waveforms are referred to as harmonics. Figure 1.12 shows the content of the harmonic frequencies that make up the distortion portion of the waveform in Figure 1.11.

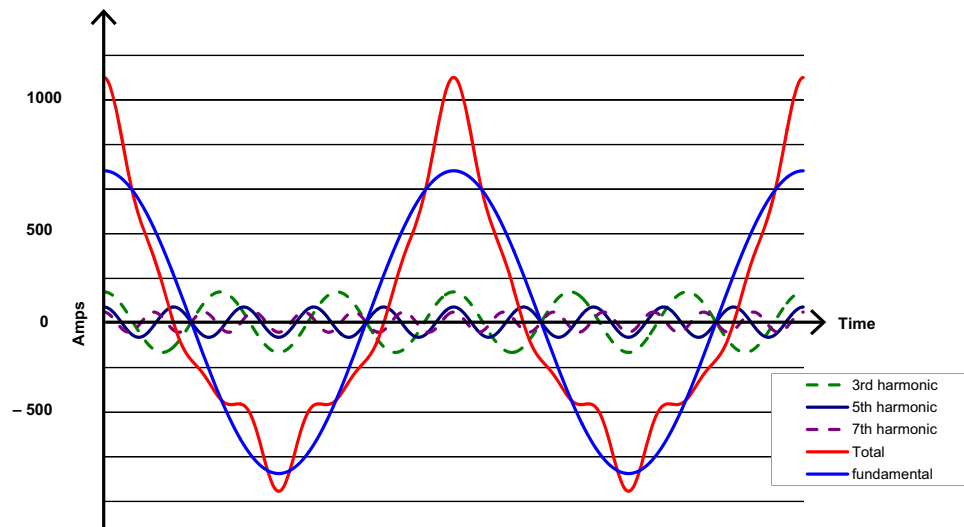

Figure 1-12: Waveforms of the Harmonics

The waveforms shown in Figure 1.12 are not smoothed but do provide an indication of the impact of combining multiple harmonic frequencies together.

When harmonics are present it is important to remember that these quantities are operating at higher frequencies. Therefore, they do not always respond in the same manner as 60 Hz values.

Inductive and capacitive impedance are present in all power systems. We are accustomed to thinking about these impedances as they perform at 60 Hz. However, these impedances are subject to frequency variation.

$$X_L = j\omega L \quad \text{and}$$

$$X_C = 1/j\omega C$$

At 60 Hz, $\omega = 377$; but at 300 Hz (5th harmonic) $\omega = 1,885$. As frequency changes impedance changes and system impedance characteristics that are normal at 60 Hz may behave entirely differently in the presence of higher order harmonic waveforms.

Traditionally, the most common harmonics have been the low order, odd frequencies, such as the 3rd, 5th, 7th, and 9th. However newer, non-linear loads are introducing significant quantities of higher order harmonics.

Since much voltage monitoring and almost all current monitoring is performed using instrument transformers, the higher order harmonics are often not visible. Instrument transformers are designed to pass 60 Hz quantities with high accuracy. These devices, when designed for accuracy at low frequency, do not pass high frequencies with high accuracy; at frequencies above about 1200 Hz they pass almost no information. So when instrument transformers are used, they effectively filter out higher frequency harmonic distortion making it impossible to see.

However, when monitors can be connected directly to the measured circuit (such as direct connection to a 480 volt bus) the user may often see higher order harmonic distortion. An important rule in any harmonics study is to evaluate the type of equipment and connections before drawing a conclusion. Not being able to see harmonic distortion is not the same as not having harmonic distortion.

It is common in advanced meters to perform a function commonly referred to as waveform capture. Waveform capture is the ability of a meter to capture a present picture of the voltage or current waveform for viewing and harmonic analysis. Typically a waveform capture will be one or two cycles in duration and can be viewed as the actual waveform, as a spectral view of the harmonic content, or a tabular view showing the magnitude and phase shift of each harmonic value. Data collected with waveform capture is typically not saved to memory. Waveform capture is a real-time data collection event.

Waveform capture should not be confused with waveform recording that is used to record multiple cycles of all voltage and current waveforms in response to a transient condition.

1.8 Power Quality

Power quality can mean several different things. The terms “power quality” and “power quality problem” have been applied to all types of conditions. A simple definition of “power quality problem” is any voltage, current or frequency deviation that results in mis-operation or failure of customer equipment or systems. The causes of power quality problems vary widely and may originate in the customer equipment, in an adjacent customer facility or with the utility.

In his book *Power Quality Primer*, Barry Kennedy provided information on different types of power quality problems. Some of that information is summarized in Table 1.3.

Table 1.3: Typical Power Quality Problems and Sources

Cause	Disturbance Type	Source
Impulse transient	Transient voltage disturbance, sub-cycle duration	Lightning Electrostatic discharge Load switching Capacitor switching
Oscillatory transient with decay	Transient voltage, sub-cycle duration	Line/cable switching Capacitor switching Load switching
Sag/swell	RMS voltage, multiple cycle duration	Remote system faults
Interruptions	RMS voltage, multiple seconds or longer duration	System protection Circuit breakers Fuses Maintenance
Under voltage/over voltage	RMS voltage, steady state, multiple seconds or longer duration	Motor starting Load variations Load dropping
Voltage flicker	RMS voltage, steady state, repetitive condition	Intermittent loads Motor starting Arc furnaces
Harmonic distortion	Steady state current or voltage, long-term duration	Non-linear loads System resonance

It is often assumed that power quality problems originate with the utility. While it is true that power quality problems can originate with the utility system, many problems originate with customer equipment. Customer-caused problems may manifest themselves inside the customer location or they may be transported by the utility system to another adjacent customer. Often, equipment that is sensitive to power quality problems may in fact also be the cause of the problem.

If a power quality problem is suspected, it is generally wise to consult a power quality professional for assistance in defining the cause and possible solutions to the problem.

EPM 2200 Power Meter

Chapter 2: Overview and Specifications

NOTICE

In European Union member state countries, this meter is NOT certified for revenue metering. See the Safety Precautions section for meter certification details.

2.1 Hardware Overview

The EPM 2200 multifunction power meters is designed for use with and/or within Industrial Control Panels in electrical substations, panel boards, and as a power meter for OEM equipment. EPM 2200 meters provide multifunction measurement of all electrical parameters.

The EPM 2200 monitor is a 0.5% class electrical panel meter. Using bright and large 0.56" LED displays, it is designed to be used in electrical panels and switchgear. The meter has a unique anti-dither algorithm to improve reading stability. The EPM 2200 meter uses high-speed DSP technology with high-resolution A/D conversion to provide stable and reliable measurements. UL 61010-1 does not address performance criteria for revenue generating watt-hour meters for use in metering of utilities and/or communicating directly with utilities, or use within a substation. Use in revenue metering, communicating with utilities, and use in substations was verified according to the ANSI and IEC standards listed in the Compliance Section (2.3).

The EPM 2200 meter is a meter and transducer in one compact unit. Featuring an optional RS485 port, it can be programmed using the faceplate of the meter or through software. ANSI or DIN mounting may be used.

EPM 2200 meter features that are detailed in this manual are as follows:

- 0.5% Class Accuracy
- Multifunction Measurement including Voltage, Current, Power, Frequency, Energy, etc.
- Percentage of Load Bar for Analog Meter Perception
- Easy to Use Faceplate Programming
- One Communication Option:
 - RS485 Modbus/KYZ output (Option S)

- BACnet MS/TP Serial Multifunction Meter with Modbus TCP/IP Internet (Option B)

2.1.1 Voltage and Current Inputs

Universal Voltage Inputs

Voltage Inputs allow measurement to 416 Volts Line-to-Neutral and 721 Volts Line-to-Line. One unit will perform to specification when directly connected to 69 Volt, 120 Volt, 230 Volt, 277 Volt, 277 Volt and 347 Volt power systems.

Current Inputs

The EPM 2200 meter Current Inputs use a unique dual input method:

Method 1: CT Pass Through

The CT passes directly through the meter without any physical termination on the meter. This insures that the meter cannot be a point of failure on the CT circuit. This is preferable for utility users when sharing relay class CTs.

Method 2: Current "Gills"

This unit additionally provides ultra-rugged Termination Pass Through Bars that allow CT leads to be terminated on the meter. This, too, eliminates any possible point of failure at the meter. This is a preferred technique for insuring that relay class CT integrity is not compromised (the CT will not open in a fault condition).

2.1.2 Order Codes

The order codes for the EPM 2200 are indicated below.

Table 2-1: EPM 2200 Order Codes

	PL2200	-	*	-	*	-	*	
Base Unit	PL2200							EPM 2200 Meter
Enclosure Option	ENC120							NEMA1 Rated - Indoor, Single Meter Enclosure, 120V
	ENC277							NEMA1 Rated - Indoor, Single Meter Enclosure, 277V
Software Option*			A1					Volts and Amps Meter
			B1					Volts, Amps, Power and Frequency Meter
			C1					Volts, Amps, Power, Frequency and Energy Counters Meter
			BN					BACnet Volts, Amps, Power, Frequency and Energy Counters meter
Communications Option			S					RS485 Serial/KYZ Pulse
			X					None
			B					BACnet MS/TP Serial and Modbus TCP/IP Internet

* Software Options are only available with Communications Option S.

For example, to order an EPM 2200 to measure Volts, Amps, Power & Frequency, with Modbus/KYZ output communications, use PL2200-XXXXXX-B1-S.

Accessories available for the EPM 2200 are indicated below.

Table 2-2: EPM 2200 Accessory Order Codes

	PL2200	-	*	-	*
DIN Bracket	PL2200	-	ACC	-	DIN

EPM 2200 Meter DIN Mounting Bracket

2.1.3 Measured Values

The following table lists the measured values available in real time, average, maximum, and minimum.

Table 2-3: EPM 2200 Measured Values

Measured Values	Real Time	Average	Maximum	Minimum
Voltage L-N	X		X	X
Voltage L-L	X		X	X
Current per phase	X	X	X	X
Current Neutral	X			
Watts	X	X	X	X
VARs	X	X	X	X
VA	X	X	X	X
Power Factor (PF)	X	X	X	X
Positive watt-hours	X			
Negative watt-hours	X			
Net watt-hours	X			
Positive VAR-hours	X			
Negative VAR-hours	X			
Net VAR-hours	X			
VA-hours	X			
Frequency	X		X	X
Voltage angles	X			
Current angles	X			
% of load bar	X			

2.1.4 Utility Peak Demand

The EPM 2200 provides user-configured Block (fixed) window, or Rolling window demand. This feature allows you to set up a customized demand profile. Block window demand is demand used over a user-configured demand period (usually 5, 15, or 30 minutes). Rolling

window demand is a fixed window demand that moves for a user-specified subinterval period. For example, a 15-minute demand using 3 subintervals and providing a new demand reading every 5 minutes, based on the last 15 minutes.

Utility demand features can be used to calculate kW, kVAR, kVA and PF readings. All other parameters offer maximum and minimum capability over the user-selectable averaging period. Voltage provides an instantaneous maximum and minimum reading which displays the highest surge and lowest sag seen by the meter.

2.2 Specifications

POWER SUPPLY

Range: Universal, (90 to 265) VAC @50/60Hz

Power consumption: 5 VA, 3.5 W

VOLTAGE INPUTS (MEASUREMENT CATEGORY III)

Range: Universal, Auto-ranging up to 416 V AC L-N, 721 V AC L-L

Supported hookups: 3-element Wye, 2.5-element Wye,
2-element Delta, 4-wire Delta

Input impedance: 1 MOhm/phase

Burden: 0.0144 VA/phase at 120 Volts

Pickup voltage: 10 V AC

Connection: Screw terminal

Maximum input wire gauge: ...AWG #12 / 2.5 mm²

Fault withstand: Meets IEEE C37.90.1

Reading: Programmable full-scale to any PT ratio

CURRENT INPUTS

Class 10: 5 A nominal, 10 A maximum

Burden: 0.005 VA per phase maximum at 11 A

Pickup current: 0.1% of nominal

Connections: O or U lug;
Pass-through wire, 0.177" / 4.5 mm maximum diameter
Quick connect, 0.25" male tab

Fault Withstand (at 23°C): 100 A / 10 seconds, 300 A / 3 seconds, 500 A / 1 second

Reading: Programmable full-scale to any CT ratio

ISOLATION

All Inputs and Outputs are galvanically isolated to 2500 V AC

ENVIRONMENTAL

Storage: -20 to 70°C

Operating: -20 to 70°C

Humidity: up to 95% RH, non-condensing

Faceplate rating: NEMA 12 (water resistant), mounting gasket included

METER ENCLOSURE ENVIRONMENTAL

Storage: -20 to 70°C

Operating: -10 to 50°C

Humidity: up to 95% RH, non-condensing

Faceplate rating: NEMA 1 (Indoor Use)

Pollution degree II

Overvoltage Category III (this product is designed for indoor use only)

MEASUREMENT METHODS

Voltage and current: True RMS

Power: Sampling at 400+ samples/cycle on all channels measured; readings
simultaneously

A/D conversion: 6 simultaneous 24-bit analog-to-digital converters

UPDATE RATE

All parameters:..... Up to 1 second

COMMUNICATIONS FORMAT

Types: RS485 port through back plate plus KYZ Pulse (Com Option S)
 RS485 serial port and RJ45 Ethernet port through backplate (Com Option B)

COMMUNICATIONS PORTS

Protocols: Modbus RTU, Modbus ASCII (Com Option S)
 Modbus TCP/IP, BACnet MS/TP Serial (Com Option B)

Baud rate:..... 9600 to 57600 bps

Port address:..... 001 to 247

Data format:..... 8 bits, no parity

MECHANICAL PARAMETERS

Dimensions: 4.25" × 4.85" × 4.85" (L × W × H)
 105.4 mm × 123.2 mm × 123.2 mm (L × W × H)

Mounting:..... mounts in 92 mm square DIN or ANSI C39.1, 4-inch round cut-out

Weight:..... 2 pounds / 0.907 kg

METER ENCLOSURE MECHANICAL PARAMETERS

Dimensions: 8.08" × 11.06" × 13.50" (L × W × H)
 205.23 mm × 280.92 mm × 342.9 mm (L × W × H)

Weight:..... 25 pounds / 11.4 kg

KYZ/RS485 PORT SPECIFICATIONS

RS485 Transceiver; meets or exceeds EIA/TIA-485 Standard:

Type: Two-wire, half duplex

Min. Input Impedance: 96kΩ

Max. Output Current: ±60mA

WH PULSE

KYZ output contacts (and infrared LED light pulses through face plate):

Pulse Width:40ms
Full Scale Frequency:6Hz
Contact type:Solid State – SPDT (NO – C – NC)
Relay type:Solid state
Peak switching voltage:DC ±350V
Continuous load current:120mA
Peak load current:350mA for 10ms
On resistance, max.:35Ω
Leakage current:1µA@350V
Isolation:AC 3750V
Reset State:(NC - C) Closed; (NO - C) Open

Infrared LED:

Peak Spectral Wavelength:940nm
Reset State:Off

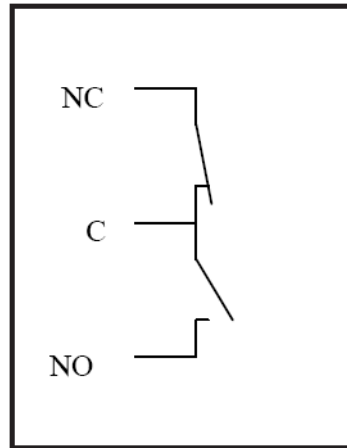

Figure 2-1: Internal Schematic (De-energized State)

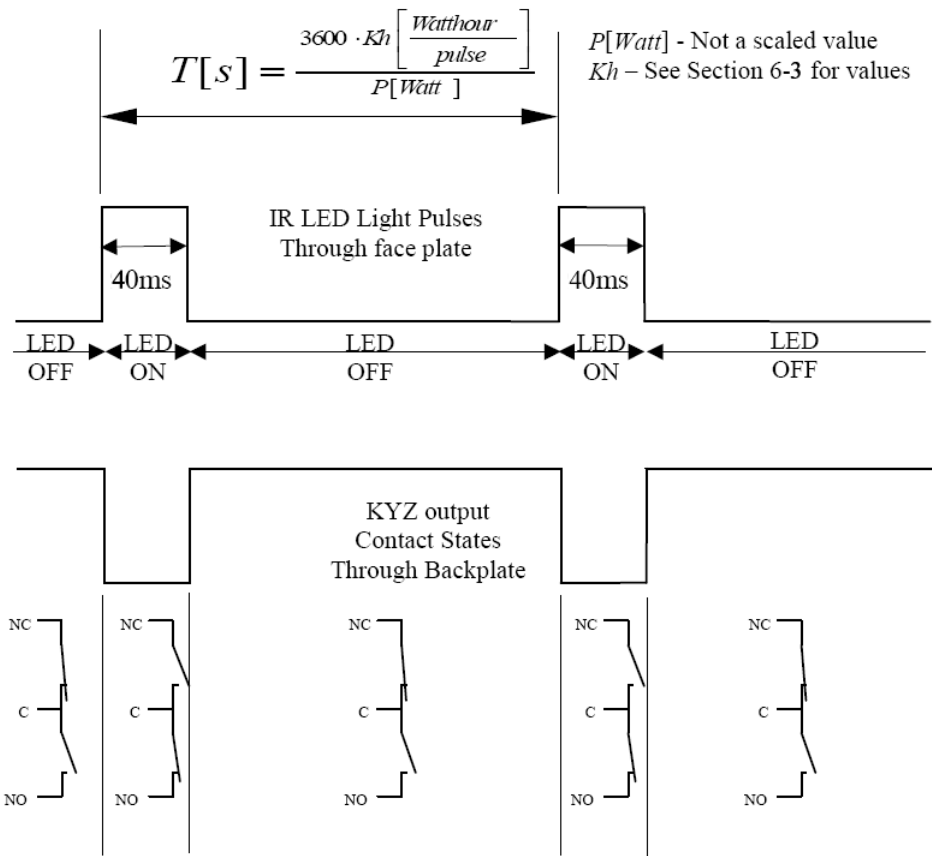

Figure 2-2: Output Timing

2.3 Compliance

Test	Reference Standard
IEC62053-22 (0.5% Accuracy)	
ANSI C12.20 (0.5% Accuracy)	
CE Compliant	
REACH Compliant	
RoHS Compliant	
Surge Withstand	ANSI (IEEE) C37.90.1
Burst	ANSI C62.41
Electrostatic Discharge	IEC61000-4-2
RF Immunity	IEC61000-4-3
Fast Transient	IEC61000-4-4
Surge Immunity	IEC61000-4-5
Conducted Disturbance Immunity	IEC61000-4-6
Magnetic Field Immunity	IEC61000-4-8
Voltage Dips and Sags Immunity	IEC61000-4-11
Immunity for Industrial Environments	EN61000-6-2
Emission Standards for Industrial Environments	EN61000-6-4
EMC Requirements	EN61326-1

APPROVALS

	Applicable Council Directive	According to:
North America	UL Recognized	UL61010-1 C22.2. No 61010-1 (PICQ7) File e200431
ISO	Manufactured under a registered quality program	ISO9001

2.4 Accuracy

For 23 °C, 3 Phase balanced Wye or Delta load.

Parameter	Accuracy	Accuracy Input Range
Voltage L-N [V]	0.2% of reading ²	(69 to 480)V
Voltage L-L [V]	0.4% of reading	(120 to 600)V
Current Phase [A]	0.2% of reading ¹	(0.15 to 5)A
Current Neutral (calculated) [A]	2% of Full Scale ¹	(0.15 to 5)A @ (45 to 65)Hz
Active Power Total [W]	0.5% of reading ^{1,2}	(0.15 to 5)A @ (69 to 480)V @ +/- (0.5 to 1) lag/lead PF
Active Energy Total [Wh]	0.5% of reading ^{1,2}	(0.15 to 5)A @ (69 to 480)V @ +/- (0.5 to 1) lag/lead PF
Reactive Power Total [VAR]	1.0% of reading ^{1,2}	(0.15 to 5)A @ (69 to 480)V @ +/- (0 to 0.8) lag/lead PF
Reactive Energy Total [VARh]	1.0% of reading ^{1,2}	(0.15 to 5)A @ (69 to 480)V @ +/- (0 to 0.8) lag/lead PF
Apparent Power Total [VA]	1.0% of reading ^{1,2}	(0.15 to 5)A @ (69 to 480)V @ +/- (0.5 to 1) lag/lead PF
Apparent Energy Total [VAh]	1.0% of reading ^{1,2}	(0.15 to 5)A @ (69 to 480)V @ +/- (0.5 to 1) lag/lead PF
Power Factor	1.0% of reading ^{1,2}	(0.15 to 5)A @ (69 to 480)V @ +/- (0.5 to 1) lag/lead PF
Frequency	+/- 0.01Hz	(45 to 65)Hz
Load Bar	+/- 1 segment ¹	(0.005 to 6)A

¹ For 2.5 element programmed units, degrade accuracy by an additional 0.5% of reading.

² For unbalanced voltage inputs where at least one crosses the 150V auto-scale threshold (for example, 120V/120V/208V system), degrade accuracy by additional 0.4%.

EPM 2200 accuracy meets the IEC62053-22 Accuracy Standards for 0.5% Class Meters. This standard is shown in the table below.

Value of Current	Power Factor	Percentage Error Limits for Meters of Class 0.5 S
$0.01 I_n \leq I < 0.05 I_n$	1	±1.0
$0.05 I_n \leq I \leq I_{max}$	1	±0.5
$0.02 I_n \leq I < 0.1 I_n$	0.5 inductive 0.8 capacitive	±1.0 ±1.0
$0.1 I_n \leq I \leq I_{max}$	0.5 inductive 0.8 capacitive	±0.6 ±0.6
When specially requested by the user, from: $0.1 I_n \leq I \leq I_{max}$	0.25 inductive 0.8 capacitive	±1.0 ±1.0



NOTE

In the table above:

I_n = Nominal (5A)

I_{max} = Full Scale

EPM 2200 Power Meter

Chapter 3: Mechanical Installation

3.1 Introduction

The EPM 2200 meter can be installed using a standard ANSI C39.1 (4" Round) or an IEC 92mm DIN (Square) form. In new installations, simply use existing DIN or ANSI punches. For existing panels, pull out old analog meters and replace with the EPM 2200 meter. The various models use the same installation. See Chapter 4 for wiring diagrams.



POTENTIAL ELECTRICAL EXPOSURE - The EPM 2200 must be installed in an electrical enclosure where any access to live electrical wiring is restricted only to authorized service personnel.

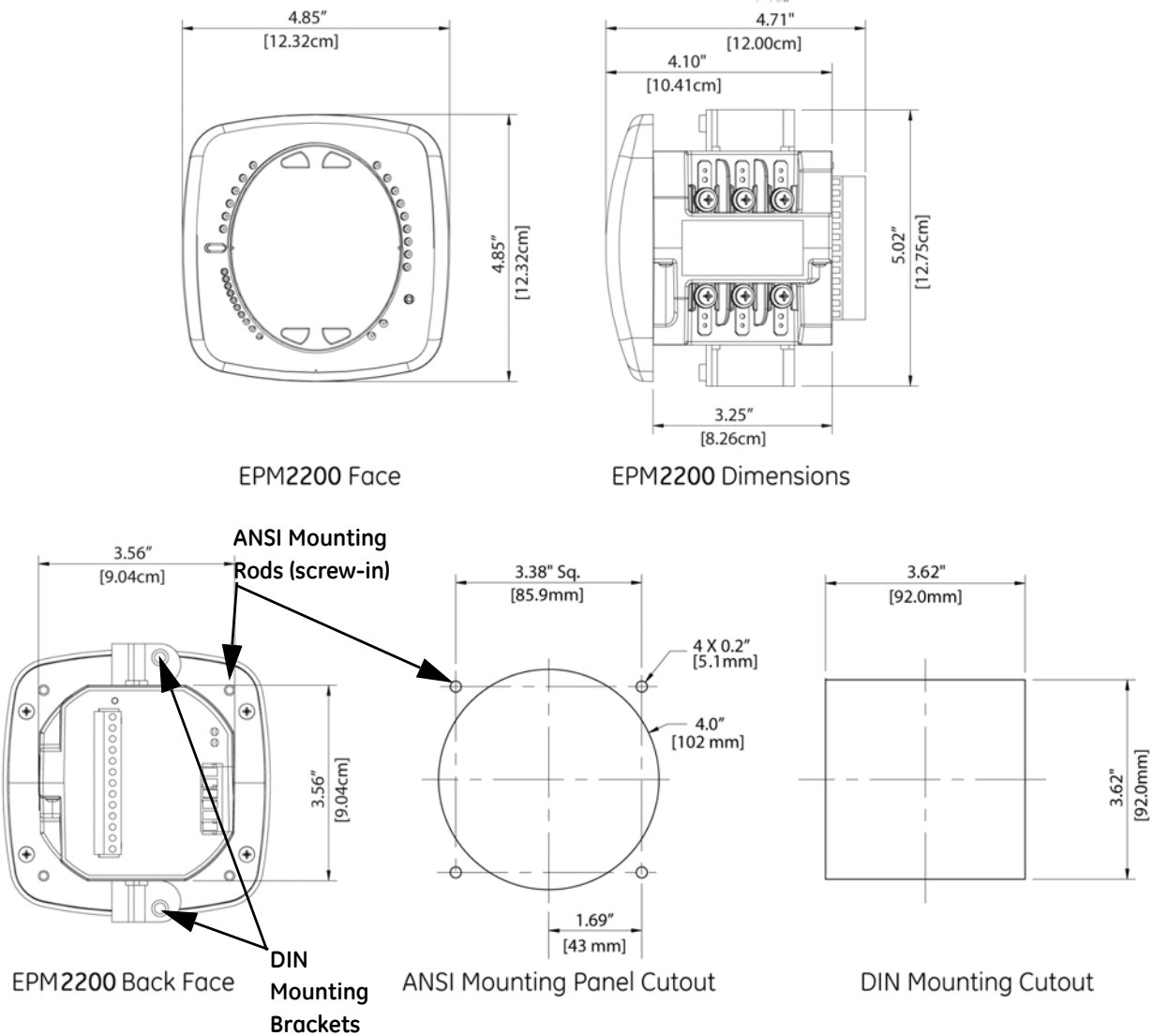

Figure 3-1: EPM 2200 Mounting Information

Recommended Tools for EPM 2200 Meter Installation:

- #2 Phillips screwdriver, small wrench and wire cutters.
- Mount the meter in a dry location free from dirt and corrosive substances. The meter is designed to withstand harsh environmental conditions. (See Environmental Specifications in 2.2 *Specifications* on page 2-4.)

3.2 ANSI Installation Steps

1. Insert 4 threaded rods by hand into the back of meter. Twist until secure.
2. Slide ANSI 12 Mounting Gasket onto back of meter with rods in place.
3. Slide meter into panel.

- Secure from back of panel with lock washer and nut on each threaded rod. Use a small wrench to tighten. Do not overtighten. The maximum installation torque is 0.4 Newton-Meter.

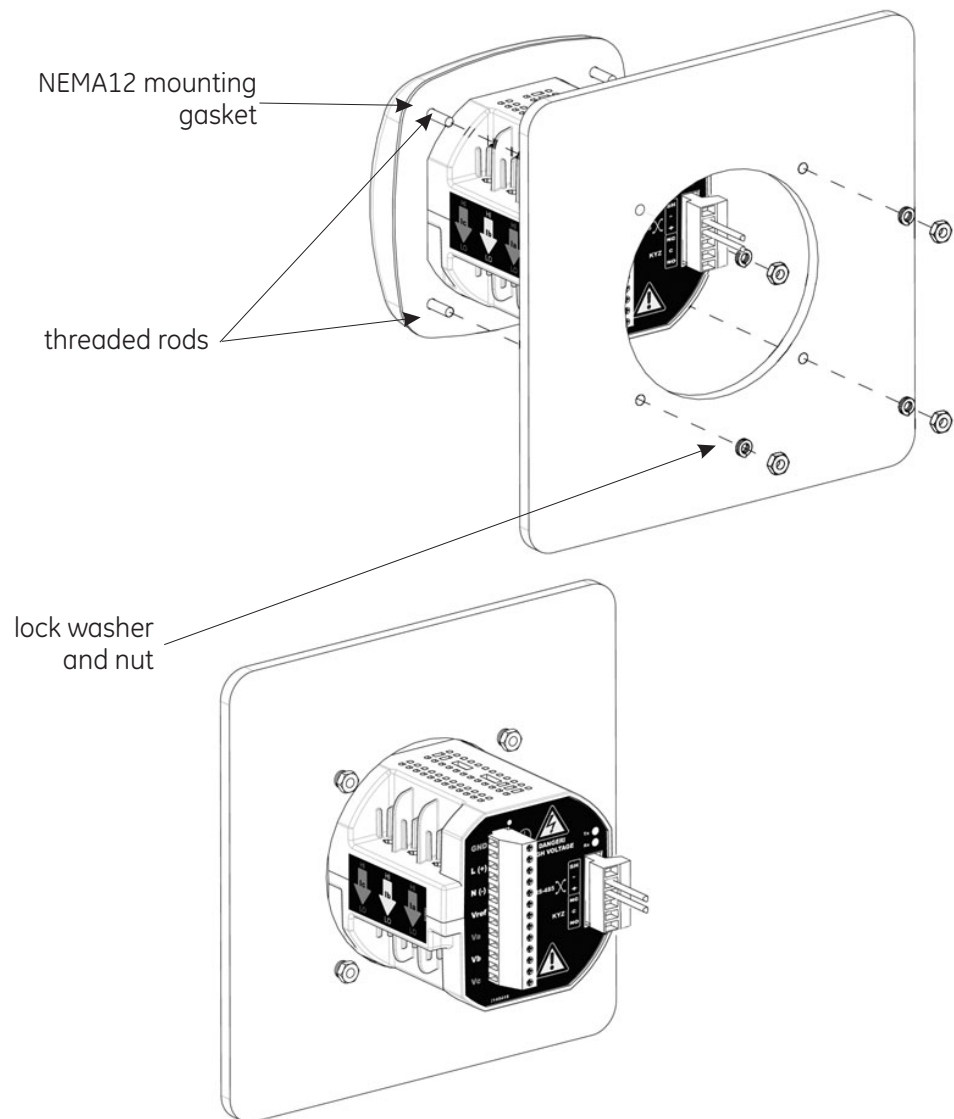

Figure 3-2: ANSI Mounting Procedure

3.3 DIN Installation Steps

- Slide meter with NEMA 12 Mounting Gasket into panel. (Remove ANSI Studs, if in place.)
- From back of panel, slide 2 DIN Mounting Brackets into grooves in top and bottom of meter housing. Snap into place.
- Secure meter to panel with lock washer and a #8 screw through each of the 2 mounting brackets. Tighten with a #2 Phillips screwdriver. Do not overtighten. The maximum installation torque is 0.4 Newton-Meter.

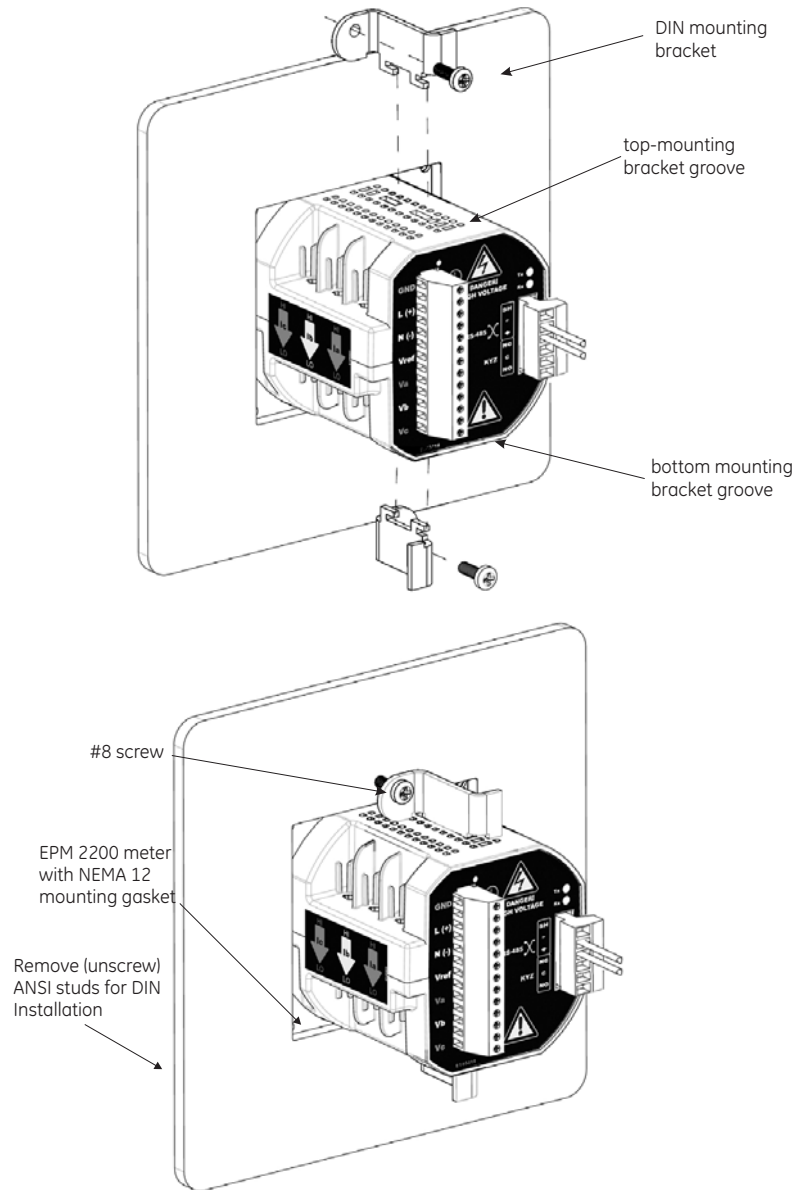

Figure 3-3: DIN Mounting Procedure

EPM 2200 Power Meter

Chapter 4: Electrical Installation

4.1 Considerations When Installing Meters

WARNING

POTENTIAL ELECTRICAL EXPOSURE - The EPM 2200/6010T must be installed in an electrical enclosure where any access to live electrical wiring is restricted only to authorized service personnel.

- Installation of the EPM 2200 Meter must be performed by only qualified personnel who follow standard safety precautions during all procedures. Those personnel should have appropriate training and experience with high voltage devices. Appropriate safety gloves, safety glasses and protective clothing is recommended.
- During normal operation of the EPM 2200 Meter, dangerous voltages flow through many parts of the meter, including: Terminals and any connected CTs (Current Transformers) and PTs (Potential Transformers), all I/O Modules (Inputs and Outputs) and their circuits. All Primary and Secondary circuits can, at times, produce lethal voltages and currents. Avoid contact with any current-carrying surfaces.
- **Do not use the meter or any I/O Output Device for primary protection or in an energy-limiting capacity. The meter can only be used as secondary protection.**
- Do not use the meter for applications where failure of the meter may cause harm or death. Do not use the meter for any application where there may be a risk of fire.
- All meter terminals should be inaccessible after installation.
- Do not apply more than the maximum voltage the meter or any attached device can withstand. Refer to meter and/or device labels and to the Specifications for all devices before applying voltages. Do not HIPOT/Dielectric test any Outputs, Inputs or Communications terminals.

- GE requires the use of **Fuses** for voltage leads and power supply and **Shorting Blocks** to prevent hazardous voltage conditions or damage to CTs, if the meter needs to be removed from service. **CT grounding is optional, but recommended.**

NOTICE

The current inputs are only to be connected to external current transformers provided by the installer. The CT's shall be Listed or Approved and rated for the current of the meter used.

CAUTION

If the equipment is used in a manner not specified by the manufacturer, the protection provided by the equipment may be impaired.

NOTICE

There is no required preventive maintenance or inspection necessary for safety. However, any repair or maintenance should be performed by the factory.

CAUTION

DISCONNECT DEVICE: A switch or circuit-breaker shall be included in the end-use equipment or building installation. The switch shall be in close proximity to the equipment and within easy reach of the operator. The switch shall be marked as the disconnecting device for the equipment.

4.1.1 CT Leads Terminated to Meter

The EPM 2200 is designed to have Current Inputs wired in one of three ways. *Figure 4-1: CT leads terminated to meter, #8 screw for lug connection* below, shows the most typical connection where CT Leads are terminated to the meter at the Current Gills.

This connection uses Nickel-Plated Brass Studs (Current Gills) with screws at each end. This connection allows the CT wires to be terminated using either an "O" or a "U" lug. Tighten the screws with a #2 Phillips screwdriver. The maximum installation torque is 1 Newton-Meter.

Other current connections are shown in Figures 4-2 and 4-3. A Voltage and RS-485 Connection is shown in Figure 4-4: *Voltage Connection* on page 4-6.

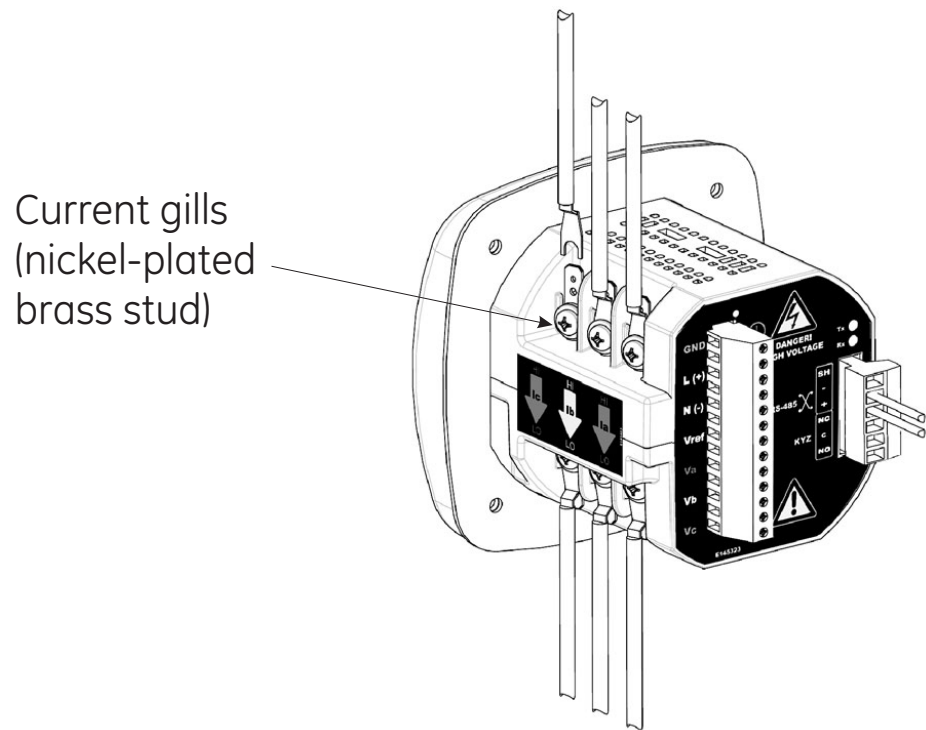

Figure 4-1: CT leads terminated to meter, #8 screw for lug connection

Wiring diagrams are detailed in the diagrams shown below in this chapter. Communications connections are detailed in *Chapter 5*.

4.1.2 CT Leads Pass-Through (No Meter Termination)

The second method allows the CT wires to pass through the CT Inputs without terminating at the meter. In this case, remove the current gills and place the CT wire directly through the CT opening. The opening will accommodate up to 0.177" / 4.5 mm maximum diameter CT wire.

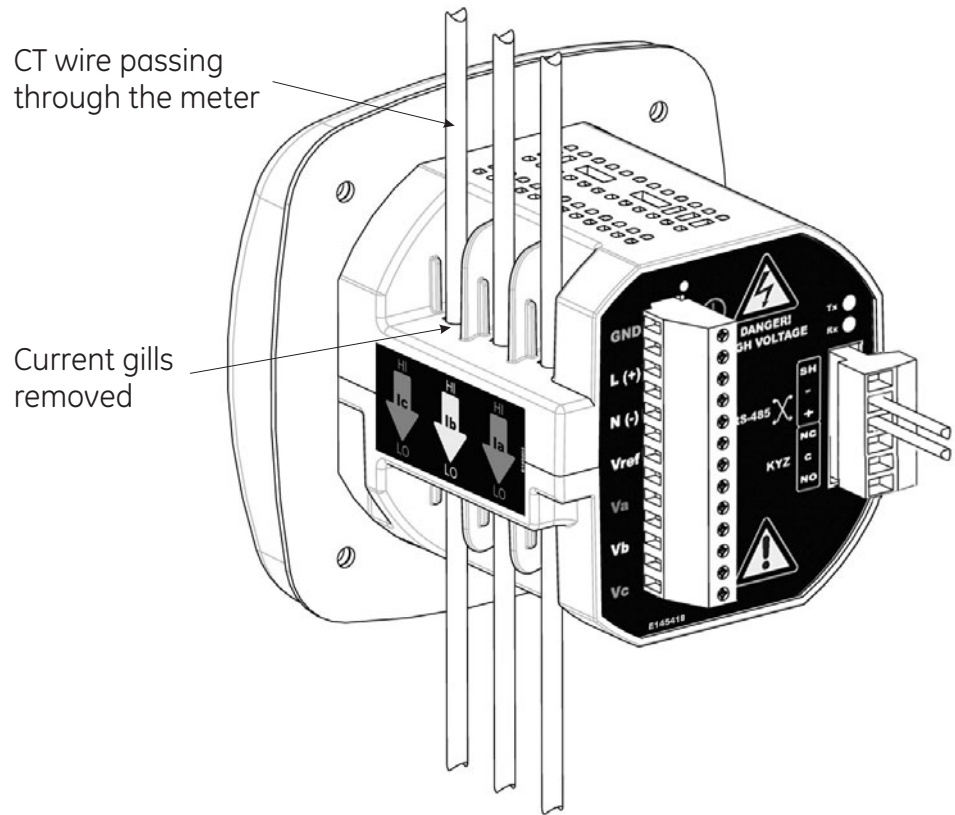

Figure 4-2: Pass-Through Wire Electrical Connection

4.1.4 Voltage and Power Supply Connections

Voltage Inputs are connected to the back of the unit via a optional wire connectors. The connectors accommodate up to AWG#12 / 2.5 mm wire.

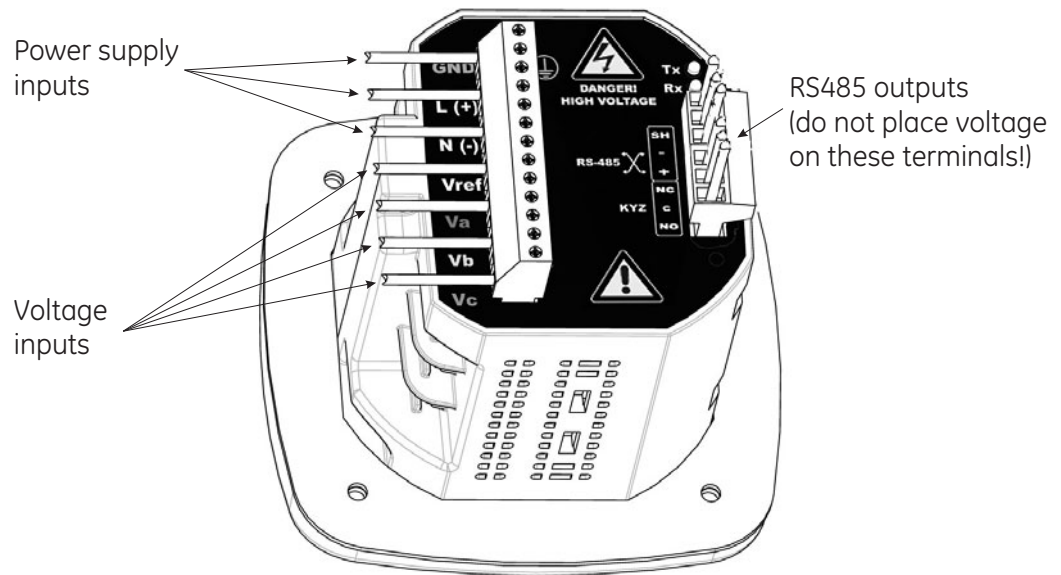

Figure 4-4: Voltage Connection

4.1.5 Ground Connections

The EPM 2200 ground terminals (⊕) should be connected directly to the installation's protective earth ground. Use 2.5 mm wire for this connection.

4.1.6 Voltage Fuses

GE requires the use of fuses on each of the sense Voltages and on the control power.

- Use a 0.1 Amp fuse on each voltage input.
- Use a 3.0 Amp fuse on the Power Supply.

4.2 Electrical Connection Diagrams

4.2.1 Description

Choose the diagram that best suits your application and maintains the CT polarity.

(1) *Wye, 4-Wire with no PTs and 3 CTs, no PTs, 3 Element* on page 4–8.

(1a) *Dual Phase Hookup* on page 4–9.

(1b) *Single Phase Hookup* on page 4–10.

(2) *Wye, 4-Wire with no PTs and 3 CTs, 2.5 Element* on page 4–11.

(3) *Wye, 4-Wire with 3 PTs and 3 CTs, 3 Element* on page 4–12.

(4) *Wye, 4-Wire with 2 PTs and 3 CTs, 2.5 Element* on page 4–13.

(5) *Delta, 3-Wire with no PTs, 2 CTs* on page 4–14.

(6) *Delta, 3-Wire with 2 PTs, 2 CTs* on page 4–15.

(7) *Delta, 3-Wire with 2 PTs, 3 CTs* on page 4–16.

(8) *Current-Only Measurement (Three-Phase)* on page 4–17.

(9) *Current-Only Measurement (Dual-Phase)* on page 4–18.

(10) *Current-Only Measurement (Single-Phase)* on page 4–19.

4.2.2 (1) Wye, 4-Wire with no PTs and 3 CTs, no PTs, 3 Element

For this wiring type, select **3 EL WYE** (3-element Wye) in the meter programming setup.

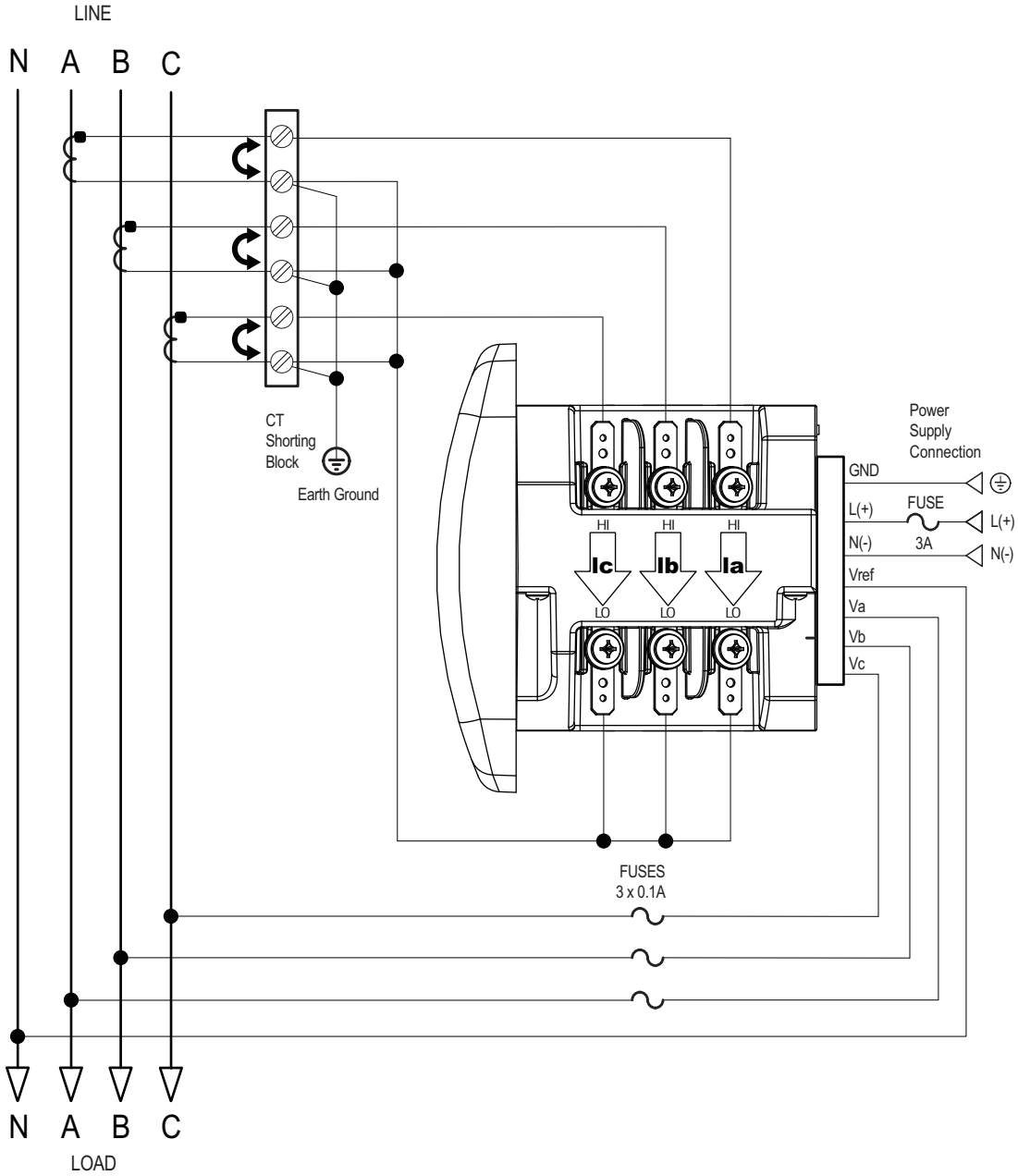
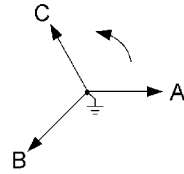

Figure 4-5: 4-Wire Wye with no PTs and 3 CTs, 3 Element

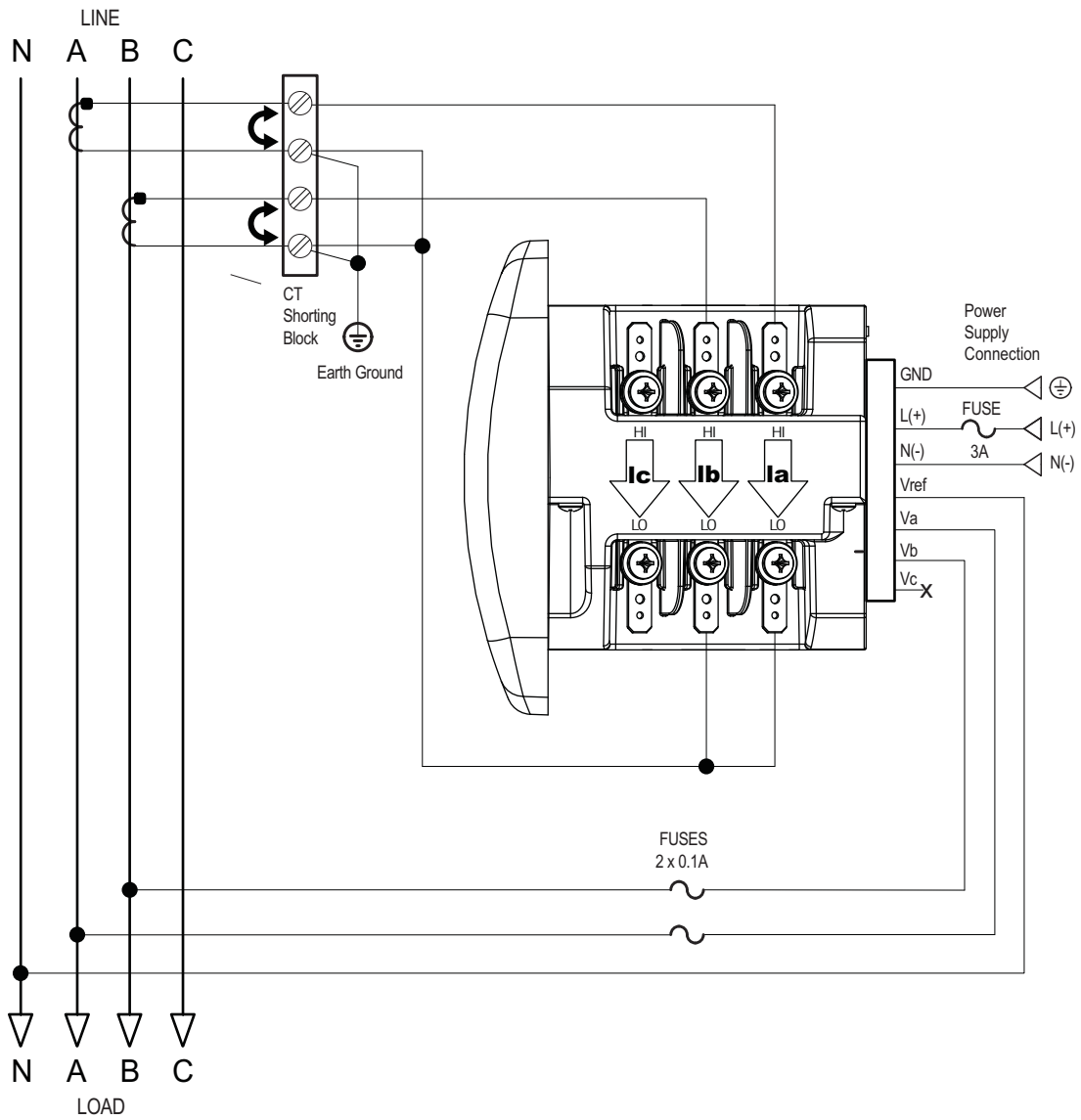

Figure 4-6: (1a) Dual Phase Hookup

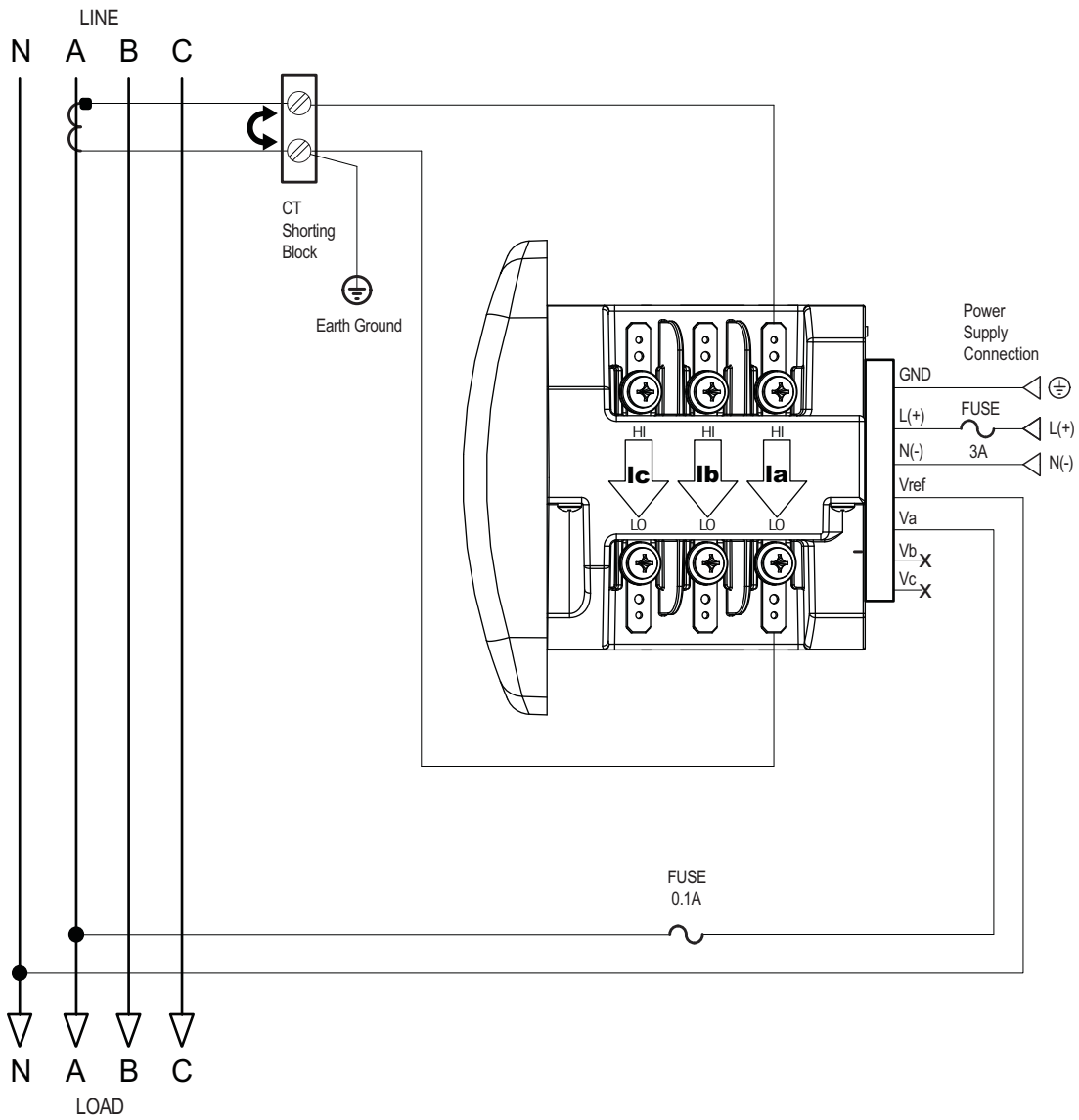

Figure 4-7: (1b) Single Phase Hookup

4.2.3 (2) Wye, 4-Wire with no PTs and 3 CTs, 2.5 Element

For this wiring type, select **2.5EL WYE** (2.5-element Wye) in the meter programming setup.

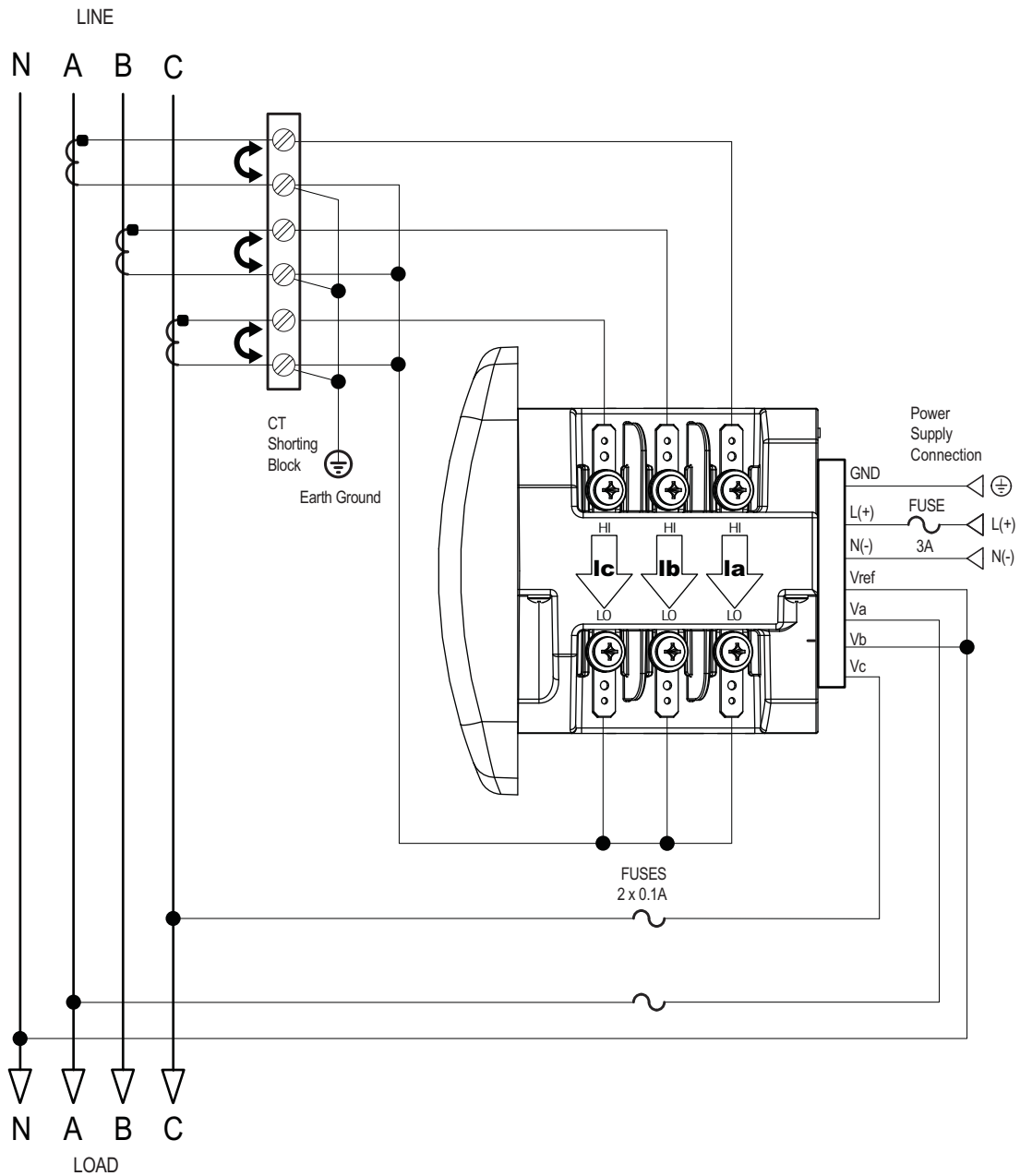
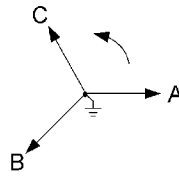

Figure 4-8: 4-Wire Wye with no PTs and 3 CTs, 2.5 Element

4.2.4 (3) Wye, 4-Wire with 3 PTs and 3 CTs, 3 Element

For this wiring type, select **3 EL WYE** (3-element Wye) in the meter programming setup.

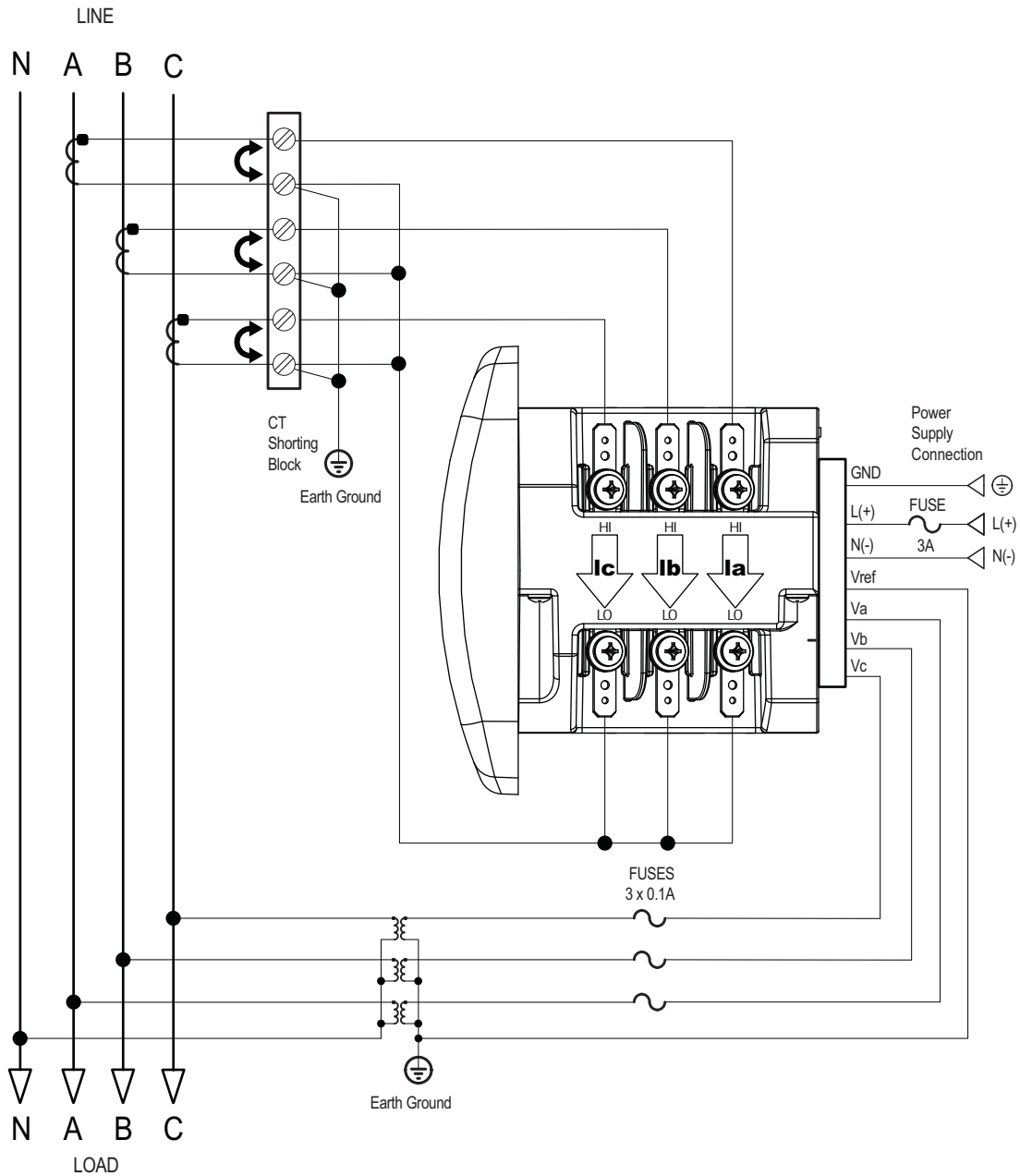
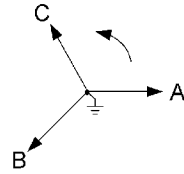

Figure 4-9: 4-Wire Wye with 3 PTs and 3 CTs, 3 Element

4.2.5 (4) Wye, 4-Wire with 2 PTs and 3 CTs, 2.5 Element

For this wiring type, select **2.5EL WYE** (2.5-element Wye) in the meter programming setup.

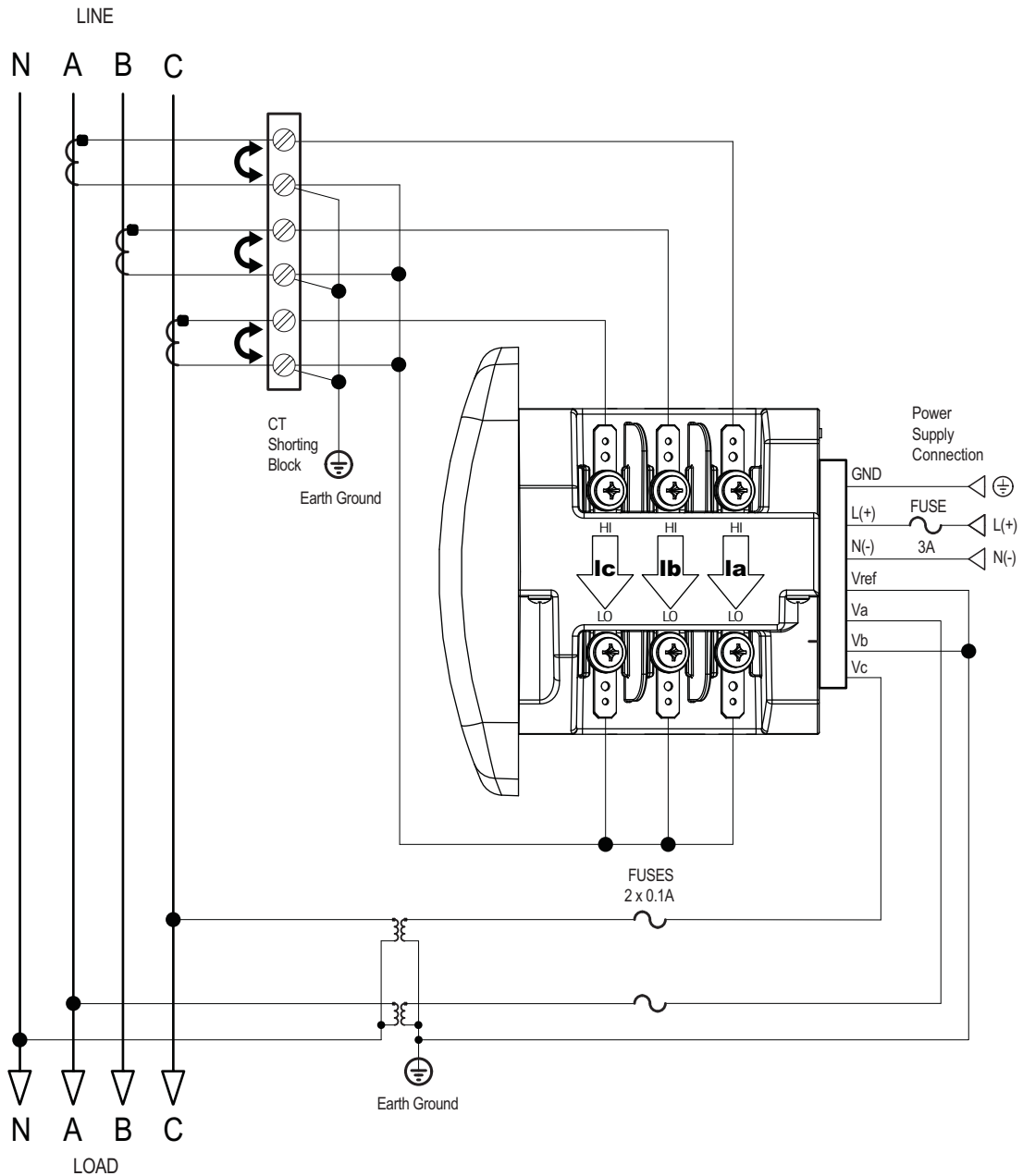
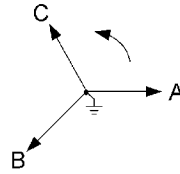

Figure 4-10: 4-Wire Wye with 2 PTs and 3 CTs, 2.5 Element

4.2.6 (5) Delta, 3-Wire with no PTs, 2 CTs

For this wiring type, select 2 Ct dEL (2 CT Delta) in the meter programming setup.

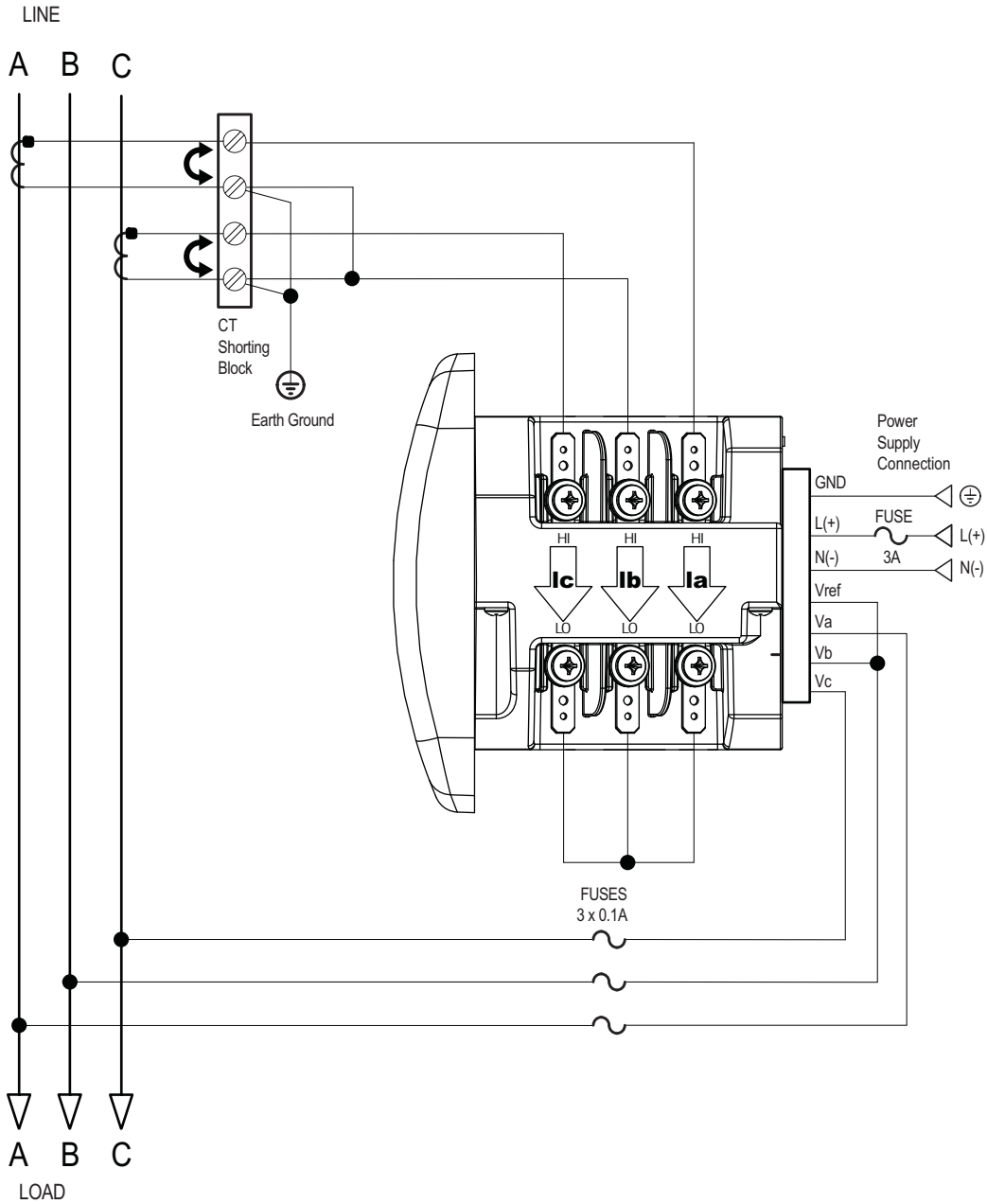
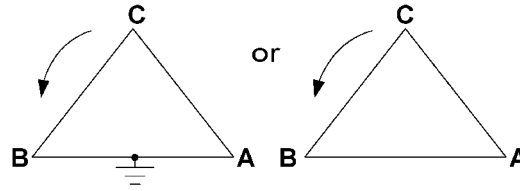

Figure 4-11: 3-Wire Delta with no PTs and 2 CTs

4.2.7 (6) Delta, 3-Wire with 2 PTs, 2 CTs

For this wiring type, select 2 Ct dEL (2 CT Delta) in the meter programming setup.

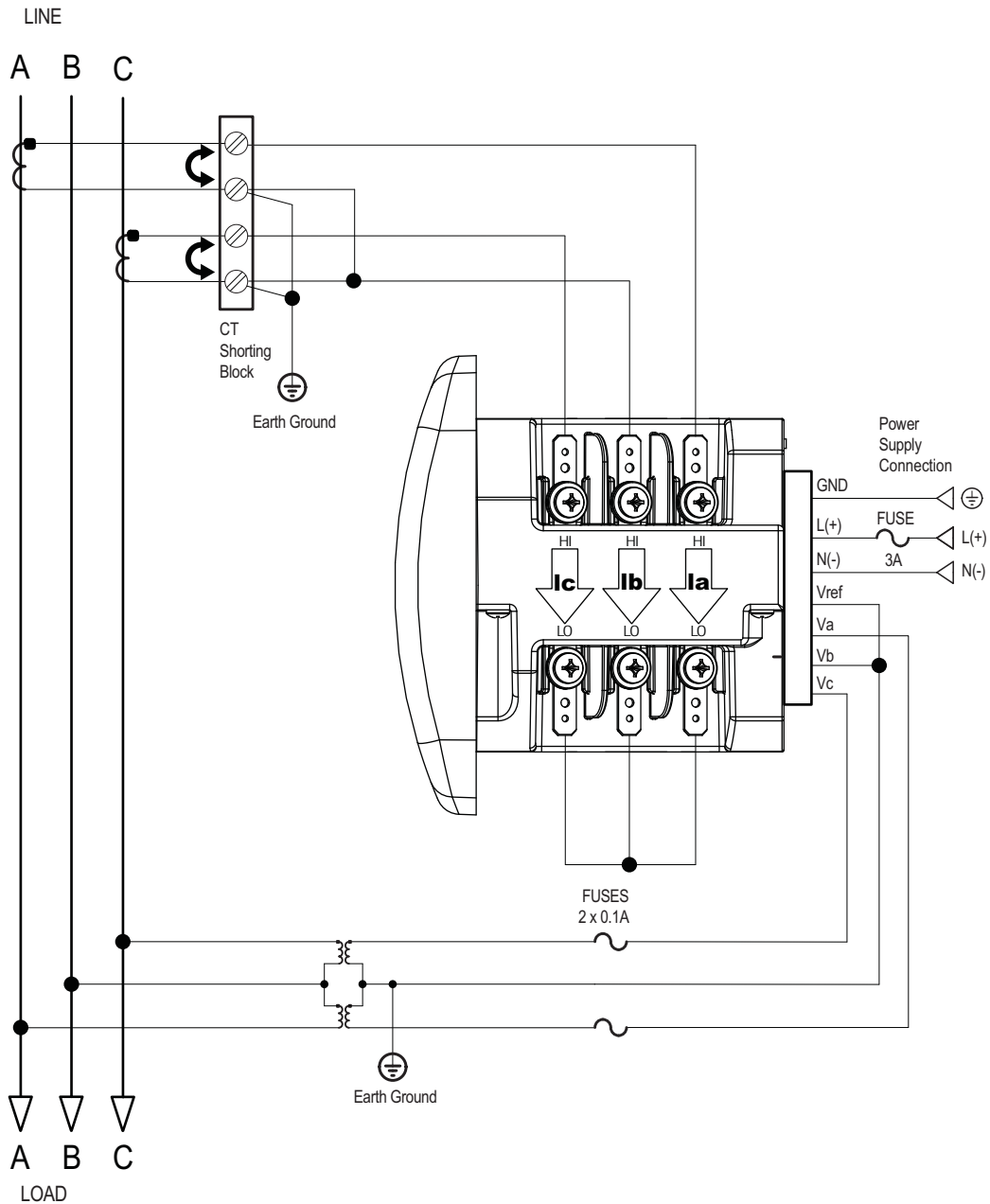
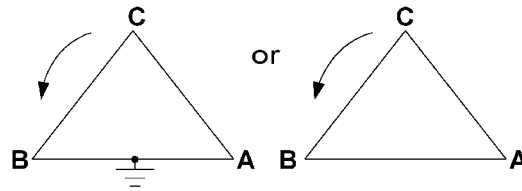

Figure 4-12: 3-Wire Delta with 2 PTs and 2 CTs

4.2.8 (7) Delta, 3-Wire with 2 PTs, 3 CTs

For this wiring type, select 2 Ct dEL (2 CT Delta) in the meter programming setup.

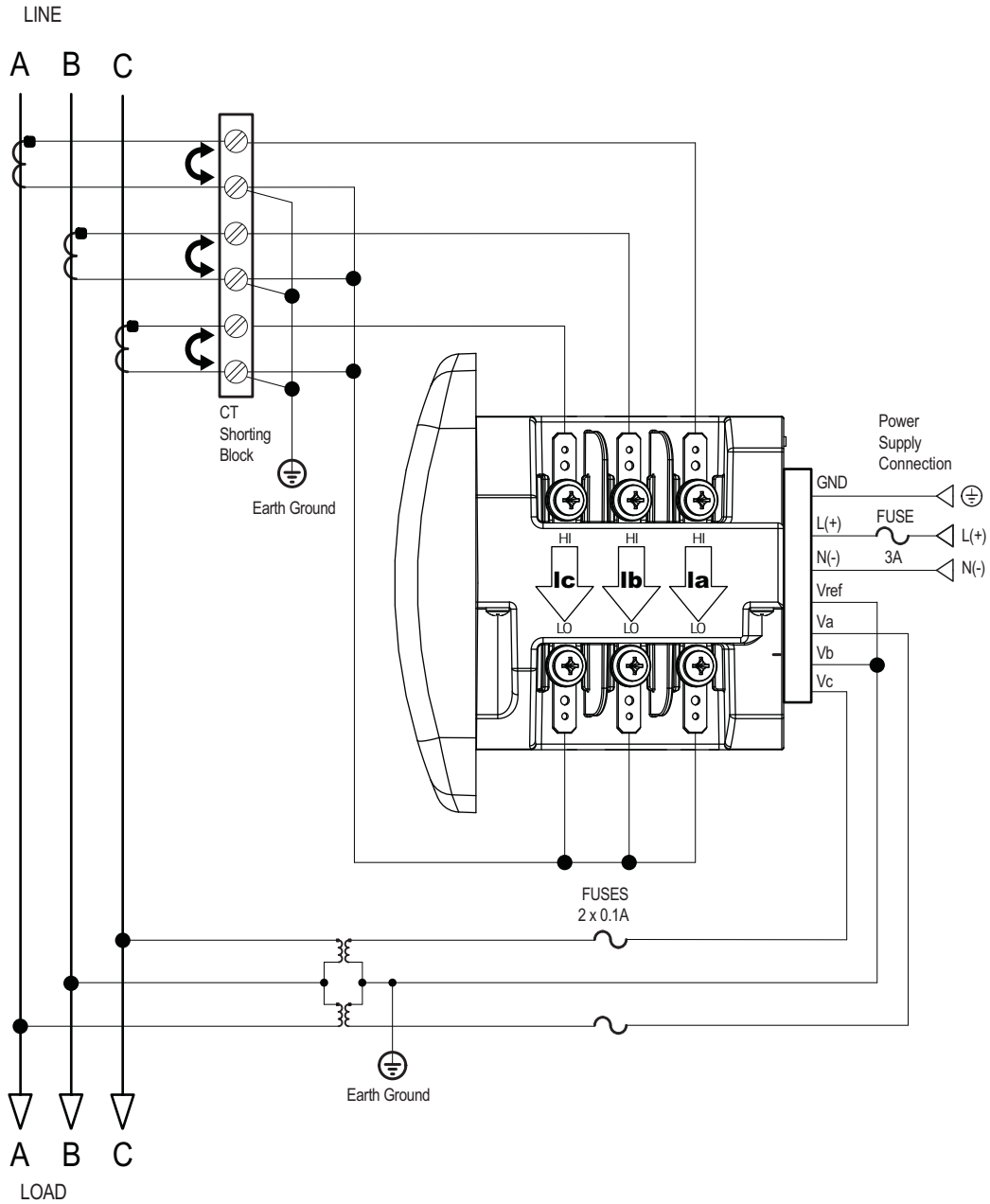
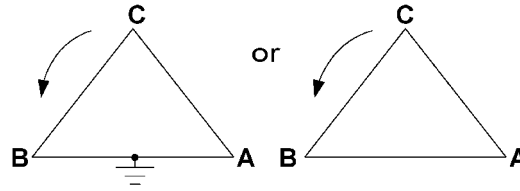

Figure 4-13: 3-Wire Delta with 2 PTs and 3 CTs

4.2.9 (8) Current-Only Measurement (Three-Phase)

For this wiring type, select **3 EL WYE** (3 Element Wye) in the meter programming setup.

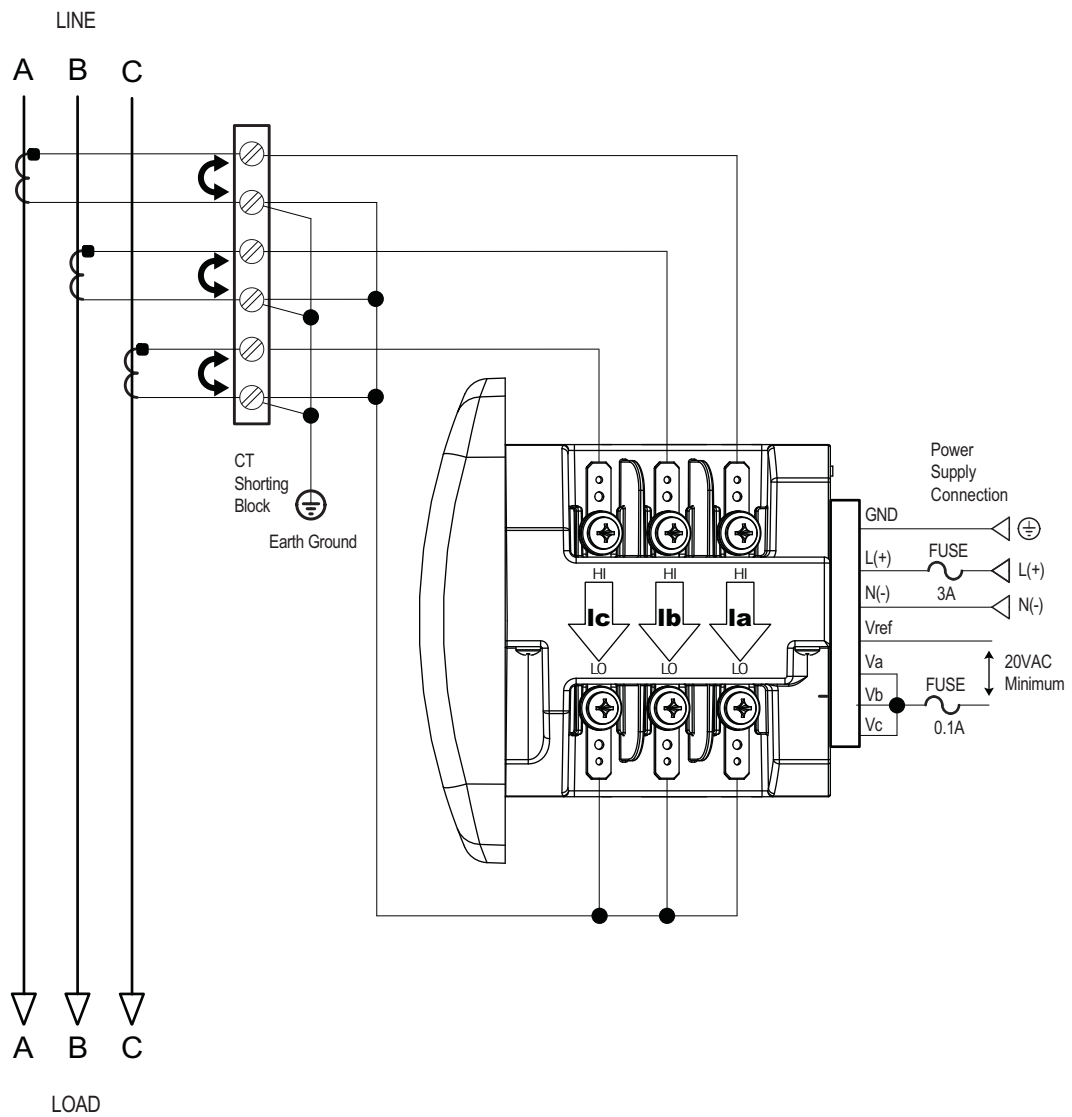

Figure 4-14: Current-Only Measurement (Three-Phase)

NOTICE

Even if the meter is used only for current measurement, the unit requires a AN volts reference. Please ensure that the voltage input is attached to the meter. AC control power can be used to provide the reference signal.

4.2.10 (9) Current-Only Measurement (Dual-Phase)

For this wiring type, select **3 EL WYE** (3 Element Wye) in the meter programming setup.

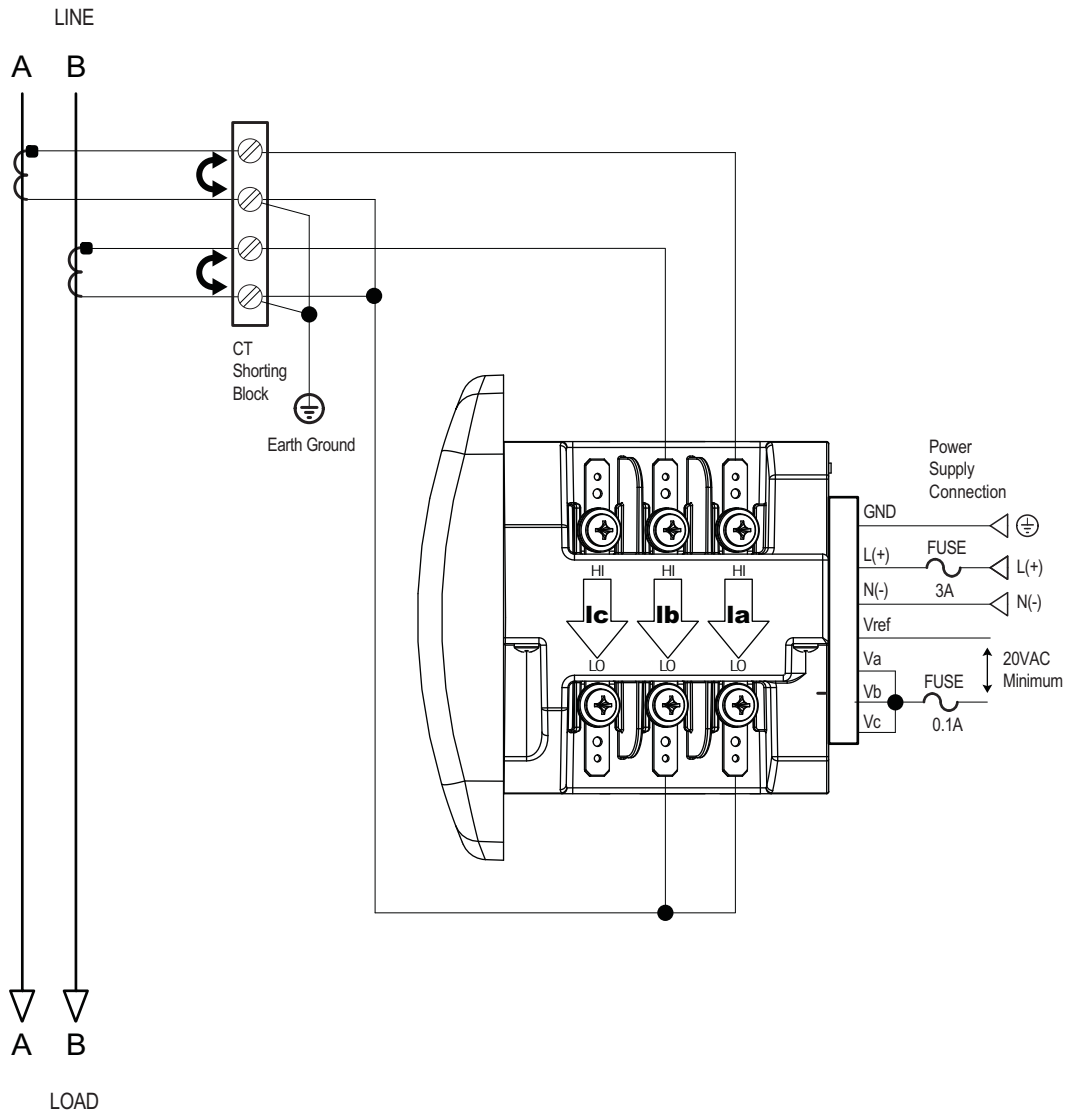

Figure 4-15: Current-Only Measurement (Dual-Phase)

NOTICE

Even if the meter is used only for current measurement, the unit requires a AN volts reference. Please ensure that the voltage input is attached to the meter. AC control power can be used to provide the reference signal.

4.2.11 (10) Current-Only Measurement (Single-Phase)

For this wiring type, select **3 EL WYE** (3 Element Wye) in the meter programming setup.

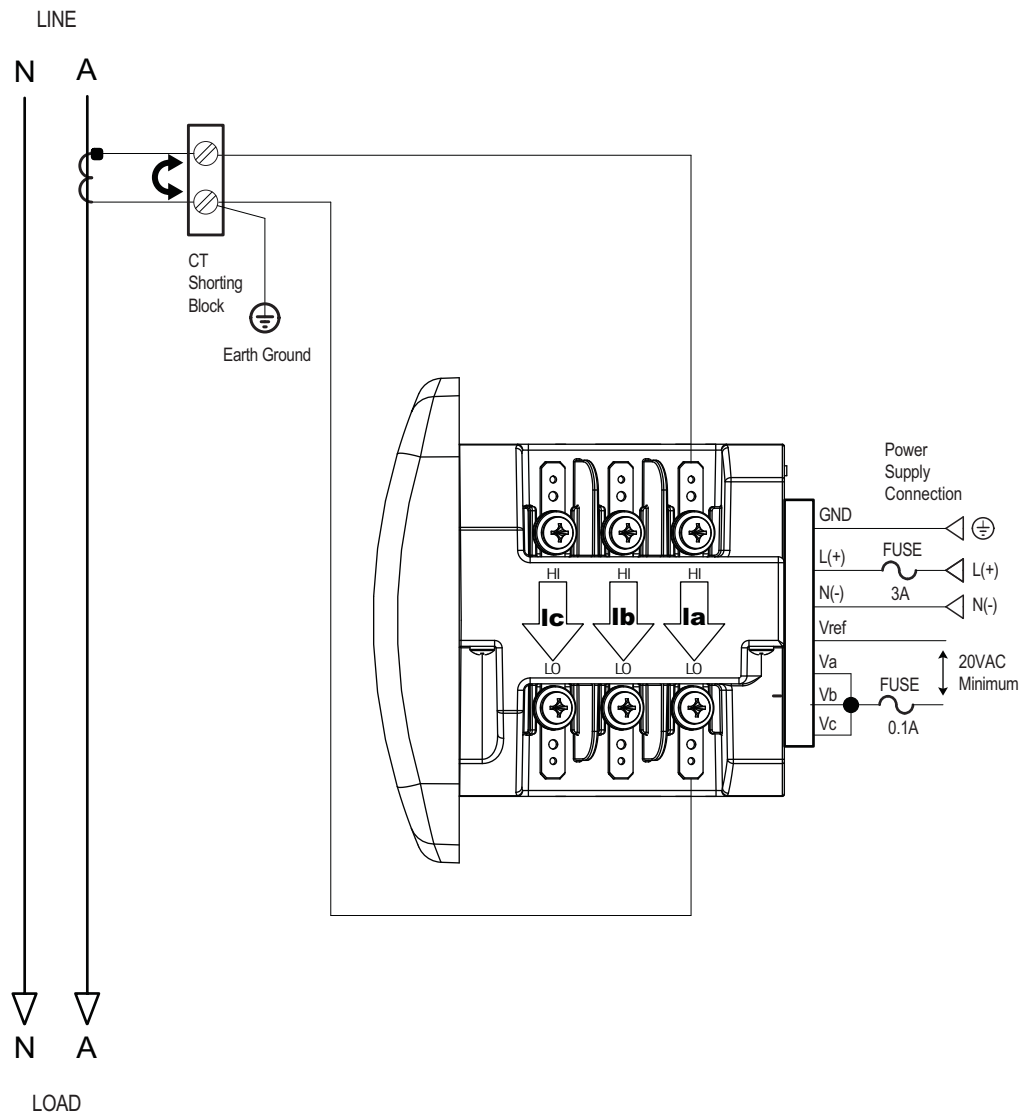

Figure 4-16: Current-Only Measurement (Single-Phase)

NOTICE

Even if the meter is used only for current measurement, the unit requires a AN volts reference. Please ensure that the voltage input is attached to the meter. AC control power can be used to provide the reference signal.

EPM 2200 Power Meter

Chapter 5: Com Option S: Modbus/ KYZ output

The Communication Options available for the EPM 2200 are connected and used in different ways.

- Com Option S: Modbus/KYZ output is explained here in Chapter 5.
- Com Option B: BACnet MS/TP with Modbus TCP/IP Internet is explained in Chapter 7 on page 7-1.

5.1 Connecting to the RS485/KYZ Output Port

The EPM 2200 Meter with Communications Option S provides a combination RS485 and a KYZ Pulse Output for pulsing energy values. The RS485 / KYZ Combo is located on the terminal section of the meter, and provides RS485 communication speaking Modbus ASCII and Modbus RTU protocols.

The EPM 2200 meter's RS485 port can be programmed with the buttons on the face of the meter or by using GE Communicator software.

The standard RS485 Port Settings are as follows:

- Address: 001 to 247
- Baud Rate: 9600, 19200, 38400 or 57600
- Protocol: Modbus RTU, Modbus ASCII

Details of changing the RS485 port settings are given in Chapter 6, using the faceplate: 6.1 *Programming Using the Faceplate* on page 6-1, and using the GE Communicator software: 6.4.2 *How to Connect Using GE Communicator Software* on page 6-17.

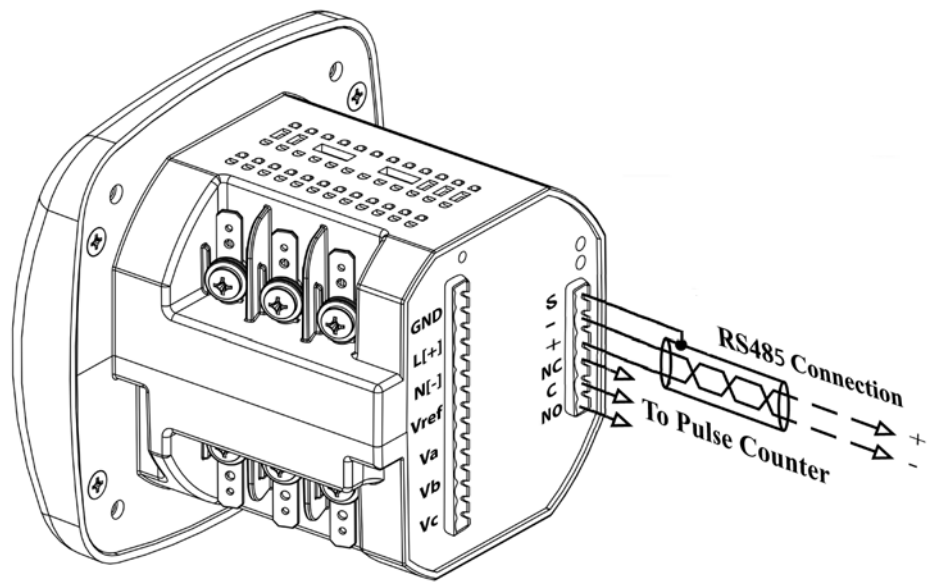

Figure 5-1: 485P Option with RS-485 Communication Installation

RS485 allows you to connect one or multiple EPM 2200 meters to a PC or other device, at either a local or remote site. All RS485 connections are viable for up to 4000 feet (1219.20 meters).

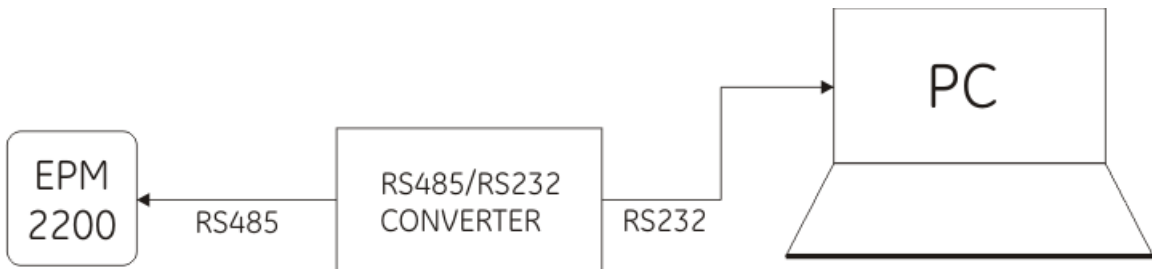
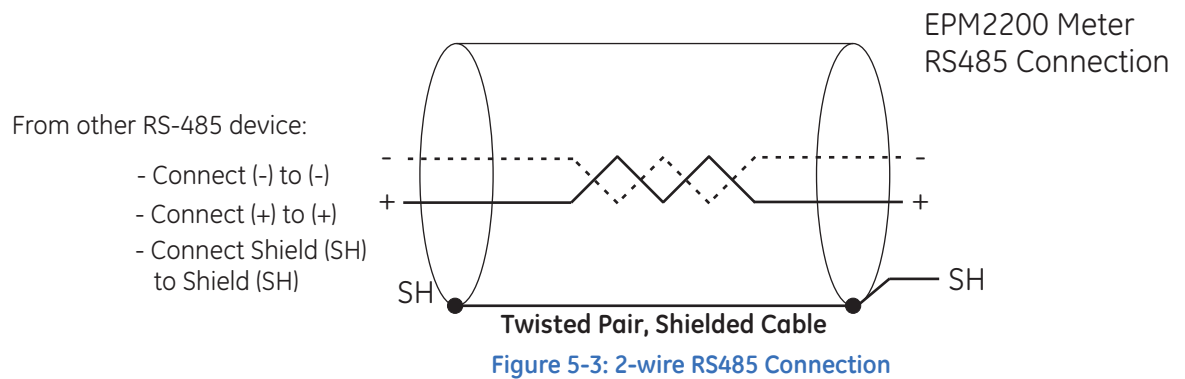

Figure 5-2: EPM 2200 Connected to PC via RS485

As shown in Figure 5-2, to connect a EPM 2200 to a PC, you need to use an RS485 to RS232 converter.

Figure 5-3 below, shows the detail of a 2-wire RS485 connection.



NOTE

For All RS485 Connections:

- Use a shielded twisted pair cable 22 AWG (0.33 mm²) or larger, grounding the shield at one end only.
- Establish point-to-point configurations for each device on a RS485 bus: connect '+' terminals to '+' terminals; connect '-' terminals to '-' terminals.
- You may connect up to 31 meters on a single bus using RS485. Before assembling the bus, each meter must be assigned a unique address: refer to the GE Communicator Instruction Manual.
- Protect cables from sources of electrical noise.
- Avoid both "Star" and "Tee" connections (see Figure 5.5).
- No more than two cables should be connected at any one point on an RS485 network, whether the connections are for devices, converters, or terminal strips.
- Include all segments when calculating the total cable length of a network. If you are not using an RS485 repeater, the maximum length for cable connecting all devices is 4000 feet (1219.20 meters).
- Connect shield to RS485 Master and individual devices as shown in Figure 5.4. You may also connect the shield to earth-ground at one point.
- Termination Resistors (RT) may be needed on both ends of longer length transmission lines. However, since the meter has some level of termination internally, Termination Resistors may not be needed. When they are used, the value of the Termination Resistors is determined by the electrical parameters of the cable.

Figure 5-4 shows a representation of an RS485 Daisy Chain connection.

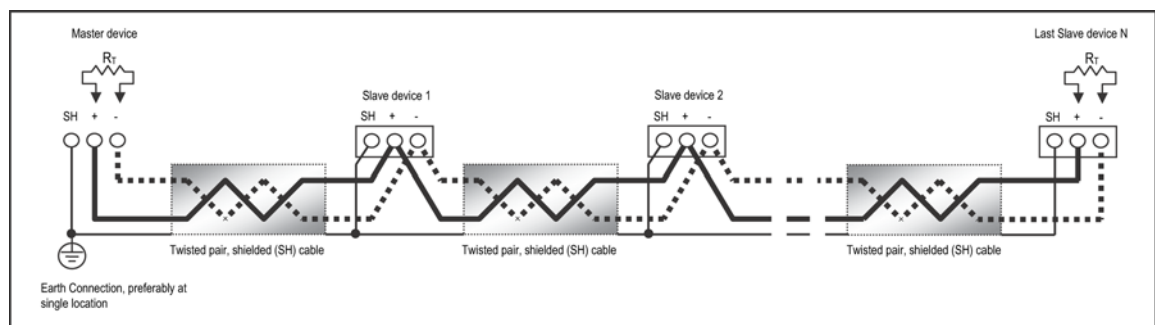

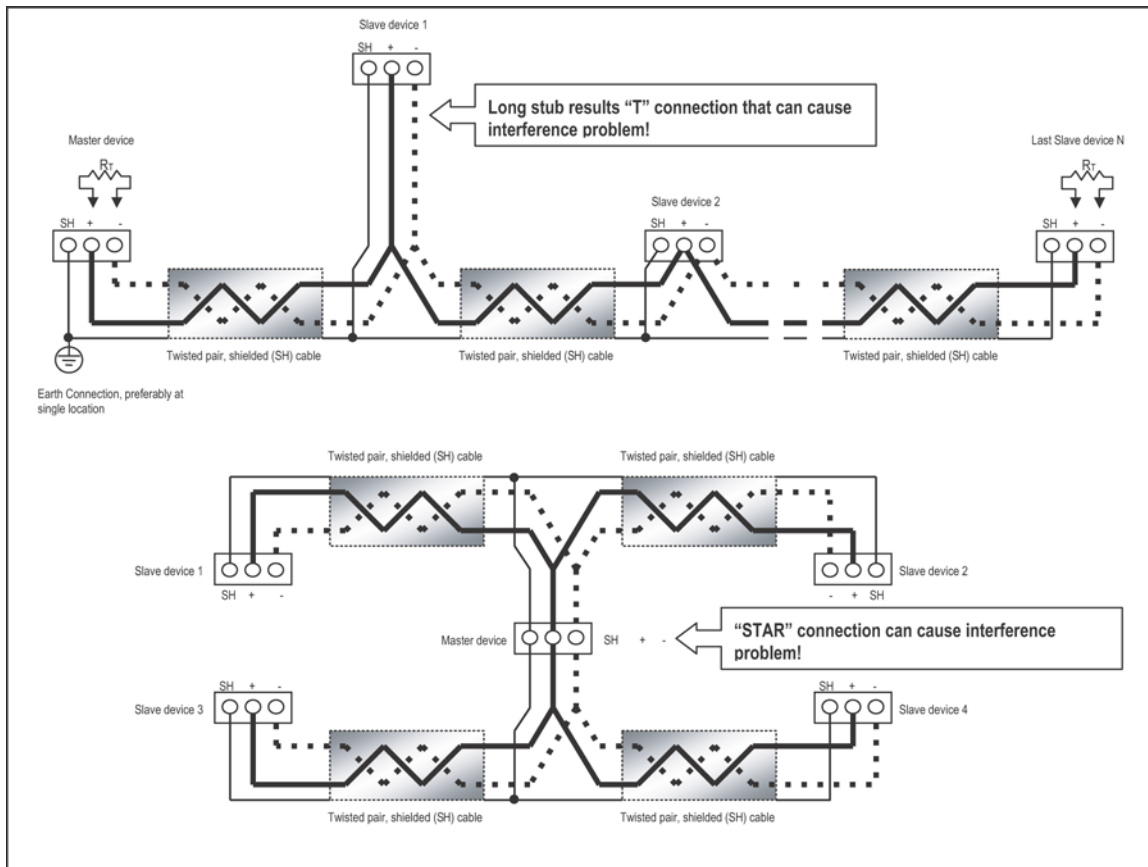

Figure 5-5: Incorrect "T" and "Star" Topologies

EPM 2200 Power Meter

Chapter 6: Using the Meter

You can use the Elements and Buttons on the EPM 2200 meter face to view meter readings, reset and/or configure the meter, and perform related functions. You can also use the GE Communicator software to configure the meter through communication.

The following sections explain meter programming, first by using the faceplate and then with GE Communicator software.

6.1 Programming Using the Faceplate

The EPM 2200 meter can be configured and a variety of functions can be accomplished simply by using the Elements and the Buttons on the meter face. Complete Navigation Maps can be found in Appendix A of this manual.

6.1.1 Meter Face Elements



Figure 6-1: Faceplate of EPM 2200 Meter with Elements

The meter face features the following elements:

- **Reading Type Indicator:**
Indicates Type of Reading
- **% of Load Bar:**
Graphic Display of Amps as % of the Load
- **Parameter Designator:**
Indicates Reading Displayed
- **Scaling Factor:**
Kilo or Mega multiplier of Displayed Readings

6.1.2 Meter Face Buttons



Figure 6-2: EPM 2200 Faceplate Buttons

Using **Menu, Enter, Down and Right Buttons**, perform the following functions:

- View Meter Information
- Enter Display Modes
- Configure Parameters (Password Protected)
- Perform Resets
- Perform LED Checks
- Change Settings
- View Parameter Values
- Scroll Parameter Values

The EPM 2200 has three MODES:

- **Operating Mode** (Default)
- **Reset Mode**
- **Configuration Mode.**

The MENU, ENTER, DOWN and RIGHT buttons navigate through the modes and navigate through all the screens in each mode.

In this chapter, a typical set up will be demonstrated. Other settings are possible. The complete Navigation Map for the Display Modes is in Appendix A of this manual. The meter can also be configured with software (see *GE Communicator Instruction Manual*).

6.1.3 Start Up

Upon Power Up, the meter will display a sequence of screens. The sequence includes the following screens:

- Lamp Test Screen where all LEDs are lighted
- Lamp Test Screen where all digits are lighted
- Firmware Screen showing build number
- Error Screen (if an error exists)

If auto-scrolling is enabled, the EPM 2200 will then automatically Auto-Scroll the Parameter Designators on the right side of the front panel. Values are displayed for each parameter.

The **KILO or MEGA LED** lights, showing the scale for the Wh, VARh and VAh readings.

An example of a Wh reading is shown here.



Figure 6-3: Typical Wh Reading

The EPM 2200 will continue to scroll through the Parameter Designators, providing readings until one of the buttons on the front panel is pushed, causing the meter to enter one of the other MODES.

6.1.4 Main Menu

Push the **MENU** button. The MAIN MENU screen appears.

- The **Reset mode** (rSt) appears in the A window. Use the Down button to scroll, causing the **Configuration** (CFG), and **Operating** (OPr) modes to move to the A window.
- The mode that is currently flashing in the A window is the “Active” mode, which means it is the mode that can be configured.

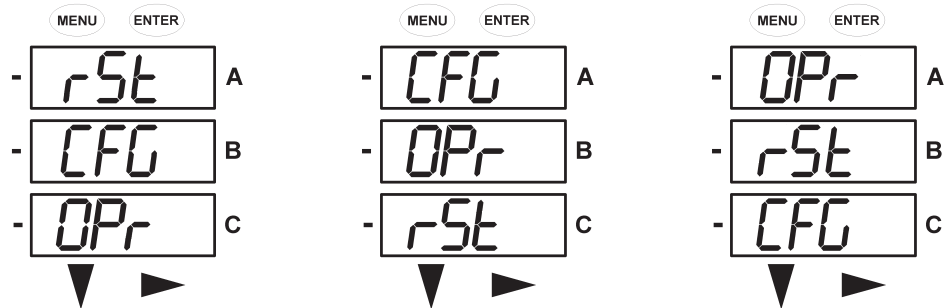
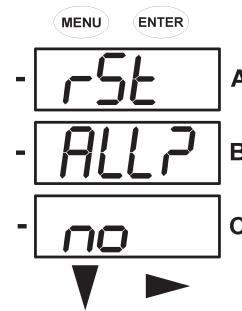

Figure 6-4: Main Menu Screens

Press the **ENTER** button from the Main Menu to view the Parameters screen for the mode that is currently active.

6.1.5 Reset Mode

1. Push **ENTER** while rSt is in the A Screen and the **rSt ALL? no** screen appears.



- If you push **ENTER** again, the Main Menu continues to scroll. (The **DOWN** button does not change the screen.)
- If you push the **RIGHT** button, the **rSt All? YES** screen appears. Press Enter to perform a reset.

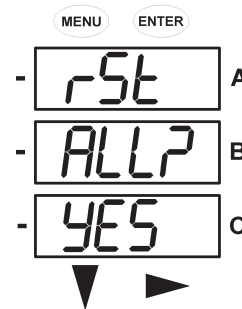

CAUTION

CAUTION! All Max and Min values will be reset.



NOTE

If Password protection is enabled in the software for reset, you must enter the four digit password before you can reset the meter.

2. Once you have performed a reset, the screen displays **rSt ALL donE** and then resumes auto-scrolling parameters.

6.1.6 Enter Password (if enabled)

If **PASSWORD** is Enabled in the software (see 6.4.3 *Device Profile Settings* on page 6–20 to Enable/Change Password), a screen appears requesting the Password. **PASS** appears in the A Screen and **4 dashes** in the B Screen. The **LEFT** digit is flashing.

1. Use the **DOWN** button to scroll from 0 to 9 for the flashing digit. When the correct number appears for that digit, use the **RIGHT** button to move to the next digit.

Example: On the Password screens below:

- On the left screen, four dashes appear and the left digit is flashing.
- On the right screen, 2 digits have been entered and the third digit is flashing.

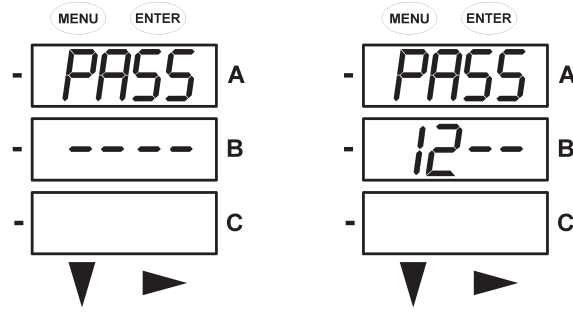

PASS or FAIL:

- When all 4 digits have been entered, push **ENTER**.

If the **correct Password** has been entered, **rSt ALL donE** appears and the screen returns to Auto-Scroll the Parameters. (In other Modes, the screen returns to the screen to be changed. The left digit of the setting is flashing and the Program (PRG) LED flashes on the left side of the meter face.)

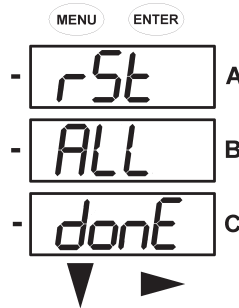

If an **incorrect Password** has been entered, **PASS ---- FAIL** appears and the screen returns to **rSt ALL? YES**.

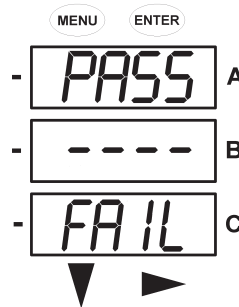

6.1.7 Configuration Mode

Navigating the configuration mode menu.

- Press the **MENU** Button from any of the auto-scrolling readings.
- Press **DOWN** to display the Configuration Mode (**CFG**) string in the A screen.

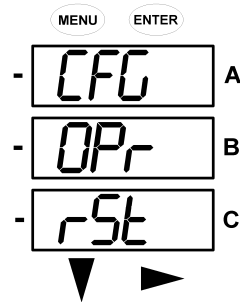

3. Press **ENTER** to scroll through the configuration parameters, starting at the **SCrL Ct Pt** screen.

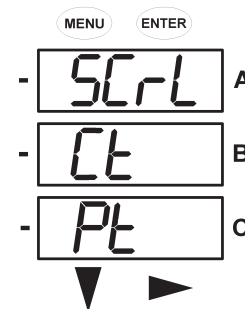

4. Push the **DOWN** Button to scroll all the parameters: scroll, CT, PT, connection (**Cnct**) and port.
The active parameter is always flashing and displayed in the A screen.

Programming the screen for configuration mode.

1. Press the **DOWN** or **RIGHT** button (for example, from the **Ct-n** message below) to display the password screen, if enabled in the software.
2. Use the **DOWN** and **RIGHT** buttons to enter the correct password (refer to *Reset Mode* on page 7-4 for steps on password entry).
3. Once the correct password is entered, push **ENTER**.
The **Ct-n** message will reappear, the PRG faceplate LED will flash, and the first digit of the "B" screen will also flash.

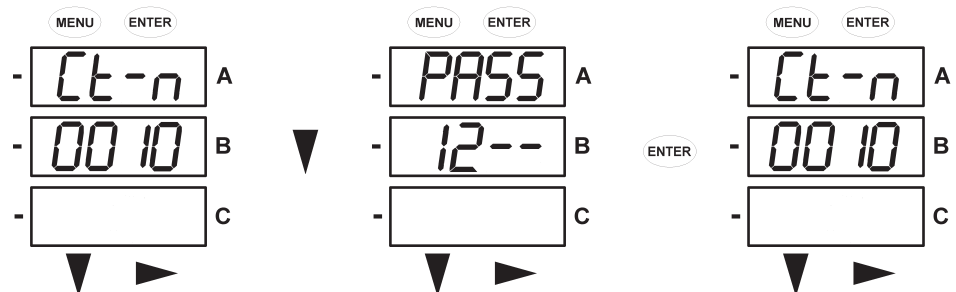

4. Use the **DOWN** button to change the first digit.
5. Use the **RIGHT** button to select and change the successive digits.
6. When the new value is entered, push **ENTER** twice.
This will display the **Stor ALL? no** screen.

- Use the **RIGHT** button to scroll to change the value from **no** to **YES**.

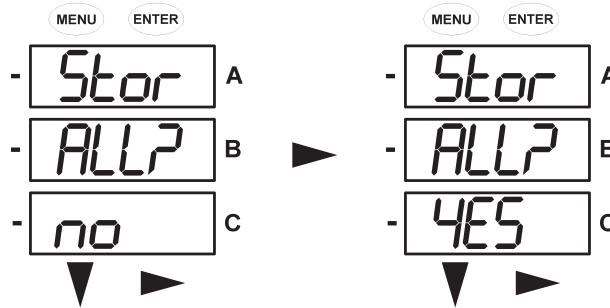

- When the **Stor ALL? YES** message is displayed, press **ENTER** to change the setting.

The **Stor ALL donE** message will appear and the meter will reset.

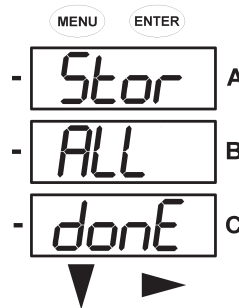

6.1.8 Configuring the Scroll Feature

When in Auto Scroll mode, the meter performs a scrolling display, showing each parameter for 7 seconds, with a 1 second pause between parameters. The parameters that the meter displays are determined by the following:

- They have been selected through software (refer to the GE Communicator Instruction Manual).
- They are available through the appropriate software options (see 2.1.2 *Order Codes* on page 2-2).

Use the following procedure to configure the scroll feature.

- Press the **ENTER** button to display the **SCrL no** message.
- Press the **RIGHT** button to change the display to **SCrL YES** as shown below.

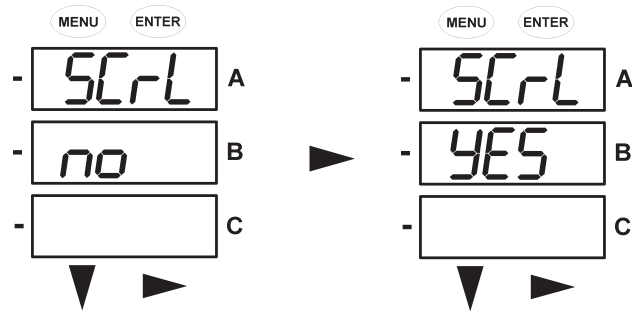

Figure 6-5: Scroll Mode Configuration

3. Push **ENTER** to select **YES** or **no**.

The screen scrolls to the CT parameters.

6.1.9 Configuring the CT Setting

Use the following procedure to program the CT setting.

1. Push the **DOWN** Button to scroll through the configuration mode parameters. Press **ENTER** when **Ct** is the active parameter (i.e. it is in the A screen and flashing).

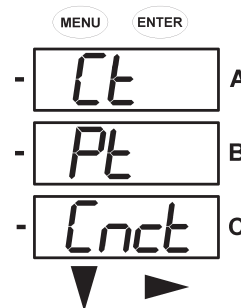

This will display the and the **Ct-n** (CT numerator) screen.

2. Press **ENTER** again to change to display the **Ct-d** (CT denominator) screen.

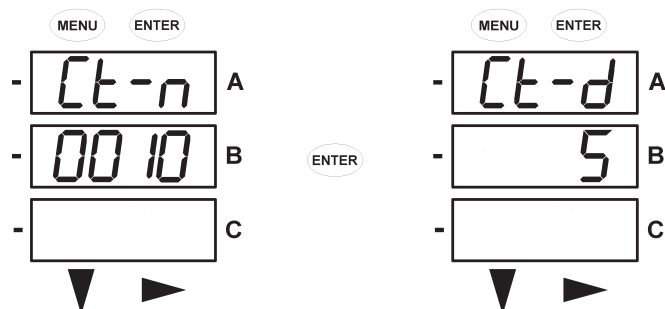

The **Ct-d** value is preset to a 1 or 5 A at the factory and cannot be changed.

3. Press **ENTER** again to select the to **Ct-S** (CT scaling) value.

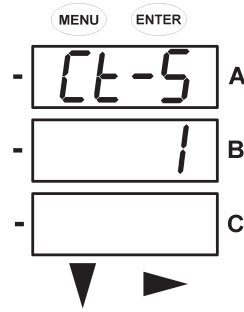

The **Ct-S** value can be “1”, “10”, or “100”. Refer to *Programming the screen for configuration mode*, on page 6–7 for instructions on changing values.

Example settings for the **Ct-S** value are shown below:

- 200/5 A:** set the **Ct-n** value for “200” and the **Ct-S** value for “1”
- 800/5 A:** set the **Ct-n** value for “800” and the **Ct-S** value for “1”
- 2000/5 A:** set the **Ct-n** value for “2000” and the **Ct-S** value for “1”.
- 10000/5 A:** set the **Ct-n** value for “1000” and the **Ct-S** value for “10”.



The value for amps is a product of the **Ct-n** and the **Ct-S** values.

4. Press **ENTER** to scroll through the other **CFG** parameters. Pressing **DOWN** or **RIGHT** displays the password screen (see *Reset Mode* on page 7–4 for details).
5. Press **MENU** to return to the main configuration menu.



Ct-n and **Ct-S** are dictated by primary current.
Ct-d is secondary current.

6.1.10 Configuring the PT Setting

Use the following procedure to program the PT setting.

1. Push the **DOWN** Button to scroll through the configuration mode parameters.
2. Press **ENTER** when **Pt** is the “active” parameter (i.e. it is in the A screen and flashing) as shown below.

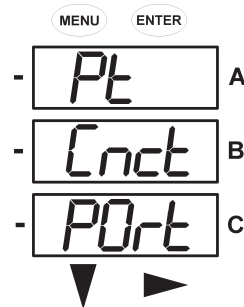

This will display the **Pt-n** (PT numerator) screen.

3. Press **ENTER** again to change to display the **Pt-d** (PT denominator) screen.

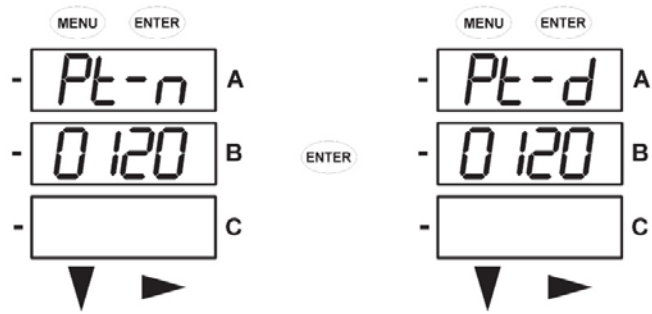

4. Press **ENTER** again to select the **Pt-S** (PT scaling) value.

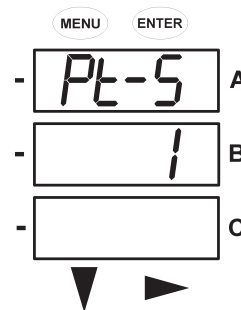

The **Pt-S** value can be "1", "10", or "100". Refer to *Programming the Configuration Mode Screens* on page 7-7 for instructions on changing values.

Example settings for the **Pt-n**, **Pt-d**, and **Pt-S** values are shown below:

277/277 Volts:	Pt-n value is 277, Pt-d value is 277, Pt-Multiplier is 1
14400/120 Volts:	Pt-n value is 1440, Pt-d value is 120, Pt-S value is 10
138000/69 Volts:	Pt-n value is 1380, Pt-d value is 69, Pt-S value is 100
345000/115 Volts:	Pt-n value is 3450, Pt-d value is 115, Pt-S value is 100
345000/69 Volts:	Pt-n value is 345, Pt-d value is 69, Pt-S value is 1000

5. Press **ENTER** to scroll through the other **CFG** parameters.
6. Press **DOWN** or **RIGHT** to display the password screen (see *Reset Mode* on page 7-4 for details).
7. Press **MENU** to return to the Main Configuration Menu.



Pt-n and **Pt-S** are dictated by primary voltage.
Pt-d is secondary voltage.

6.1.11 Configuring the Connection (Cnct) Setting

Use the following procedure to program the connection (**Cnct**) setting.

1. Push the **DOWN** Button to scroll through the Configuration Mode parameters: Scroll, CT, PT, Connection (Cnct), and Port. The "active" parameter is in the A screen and is flashing

2. Press **ENTER** when **Cnct** is the "active" parameter (i.e. it is in the A screen and flashing).

This will display the **Cnct** (Connection) screen. To change this setting, use the **RIGHT** button to scroll through the three settings. Select the setting that is right for your meter.

The possible Connection configurations are

- 3-element Wye (**3 EL WYE**)
- 2.5-element Wye (**2.5EL WYE**)
- 2 CT Delta (**2 Ct deL**)

as shown below:

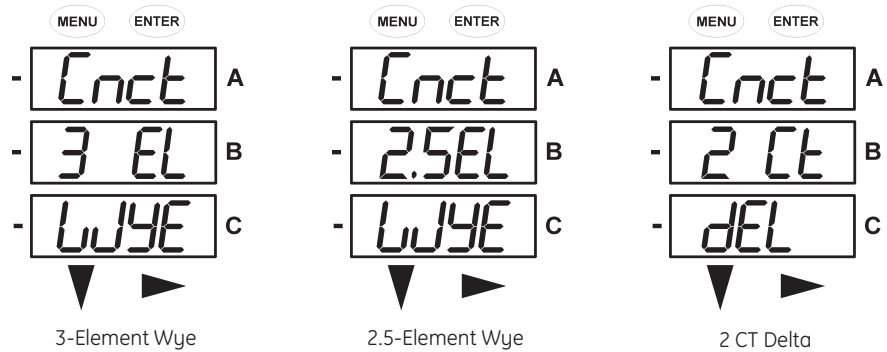

3. Press **ENTER** to scroll through the other **CFG** parameters.
4. Press **DOWN** or **RIGHT** to display the Password screen (see *Reset Mode* on page 6-4 for details).
5. Press **MENU** to return to the main Configuration menu.

6.1.12 Configuring the Communication Port Settings

Use the following procedure to program the communication port (**Port**) settings of the RS485 port if you have an EPM 2200 meter with Com Option S: RS485/KYZ output.



If you have an EPM 2200 meter with Com Option B (BACnet), the RS485 port is used only for BACnet and is not programmed.

1. Push the **DOWN** Button to scroll through the configuration mode parameters.
2. Press **ENTER** when **Port** is the active parameter (i.e. it is in the A screen and flashing) as shown below.

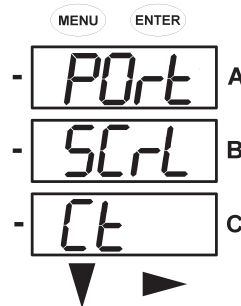

The following parameters can be configured through the **PORt** menu

- The meter **Address (Adr)**, a 3-digit number.
 - The **Baud Rate (bAUd)**. Select from “9600”, “19.2”, “38.4”, and “57.6” for 9600, 19200, 38400, and 57600 kbps, respectively.
 - The **Communications Protocol (Prot)**. Select “rtU” for Modbus RTU, and “ASCI” for Modbus ASCII.
- The first **PORt** screen is **Meter (Adr)**. The current address appears on the screen. Select a three-digit number for the address.

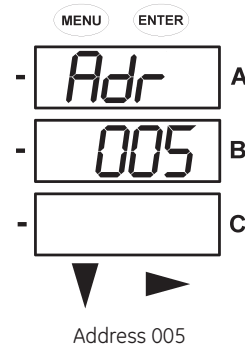

Refer to *Programming the Configuration Mode Screens* above for details on changing values.

- The next **PORt** screen is the baud rate (**bAUd**). The current baud rate is displayed on the “B” screen. Refer to *Programming the Configuration Mode Screens* above for details on changing values. The possible baud rate screens are shown below.

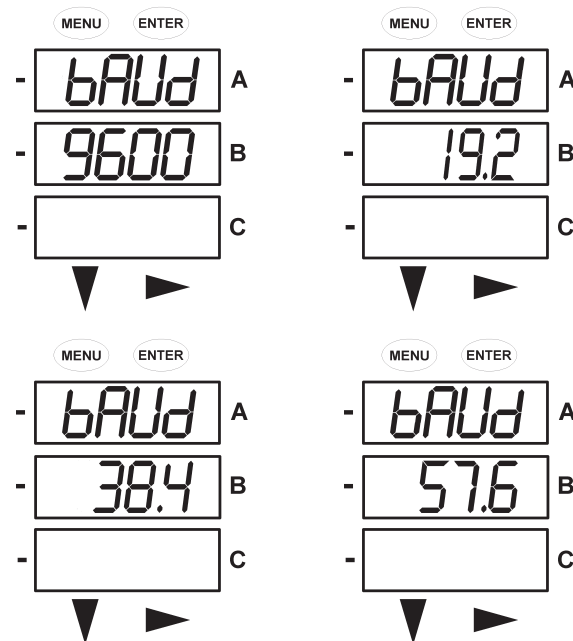

- The final **PORt** screen is the **Communications Protocol (Prot)**. The current protocol is displayed on the “B” screen.

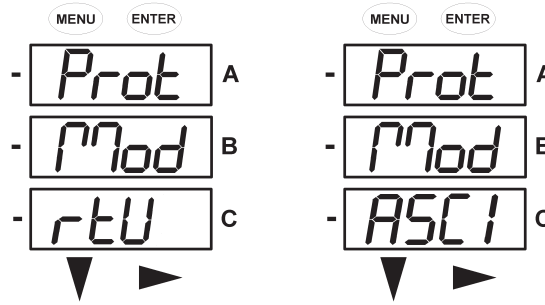

Refer to *Programming the Configuration Mode Screens* above for details on changing values. The three protocol selections are shown below.

3. Press **ENTER** to scroll through the other **CFG** parameters.
4. Press **DOWN** or **RIGHT** to display the Password screen (see *Reset Mode* on page 7-4 for details).
5. Press **MENU** to return to the main Configuration menu.

6.1.13 Operating Mode

Operating mode is the EPM 2200 meter’s default mode. If scrolling is enabled, the meter automatically scrolls through these parameter screens after startup. The screen changes every 7 seconds. Scrolling is suspended for 3 minutes after any button is pressed.

Push the **DOWN** button to scroll all the parameters in operating mode. The active parameter has the indicator light next to it on the right face of the meter.

Push the **RIGHT** button to view additional displays for that parameter. A table of the possible displays in the operating mode is below. Refer to *Appendix A: EPM 2200 Navigation Maps* on page A-1 for a detailed navigation map of the operating mode.

Table 6-1: Operating Mode Parameter Readings

Parameter designator Available by Software Option (see Order Code table)		Possible Readings				
VOLTS L-N	A1, B1, C1	VOLTS_LN	VOLTS_LN_MAX	VOLTS_LN_MIN		
VOLTS L-L	A1, B1, C1	VOLTS_LL	VOLTS_LL_MAX	VOLTS_LL_MIN		
AMPS	A1, B1, C1	AMPS	AMPS_NEUTRAL	AMPS_MAX	AMPS_MIN	
W/VAR/PF	B1, C1	W_VAR_PF	W_VAR_PF_MAX_POS	W_VAR_PF_MIN_POS	W_VAR_PF_MAX_NEG	W_VAR_PF_MIN_NEG
VA/Hz	B1, C1	VA_FREQ	VA_FREQ_MAX	VA_FREQ_MIN		
Wh	C1	KWH_REC	KWH_DEL	KWH_NET	KWH_TOT	
VARh	C1	KVARH_POS	KVARH_NEG	KVARH_NET	KVARH_TOT	
VAh	C1	KVAH				



Readings or groups of readings are skipped if not applicable to the meter type or hookup, or if explicitly disabled in the programmable settings.

6.2 % of Load Bar

The 10-segment LED bargraph at the bottom of the EPM 2200 unit display provides a graphic representation of Amps. The segments light according to the load in the %Load Segment Table below.

When the Load is over 120% of Full Load, all segments flash "On" (1.5 secs) and "Off" (0.5 secs).

Table 6-2: % Load Segments

Segments	Load \leq % Full Load
None	No Load
1	1%
1 - 2	15%
1 - 3	30%
1 - 4	45%
1 - 5	60%
1 - 6	72%
1 - 7	84%
1 - 8	96%
1 - 9	108%
1 - 10	120%
All Blink	>120%

6.3 Watt-hour Accuracy Testing (Verification)

To be certified for revenue metering, power providers and utility companies have to verify that the billing energy meter will perform to the stated accuracy. To confirm the meter's performance and calibration, power providers use field test standards to ensure that the unit's energy measurements are correct. Since the EPM 2200 is a traceable revenue meter, it contains a utility grade test pulse that can be used to gate an accuracy standard. This is an essential feature required of all billing grade meters.

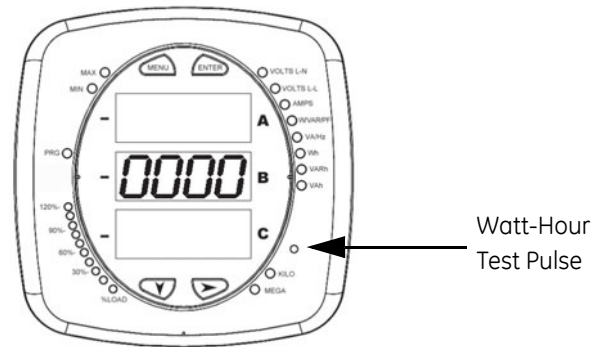

Figure 6-6: Watt-hour Test Pulse

Refer to the figure below for an example of how this test works.

Refer to Table 6-2 below for the Wh/Pulse Constant for Accuracy Testing.

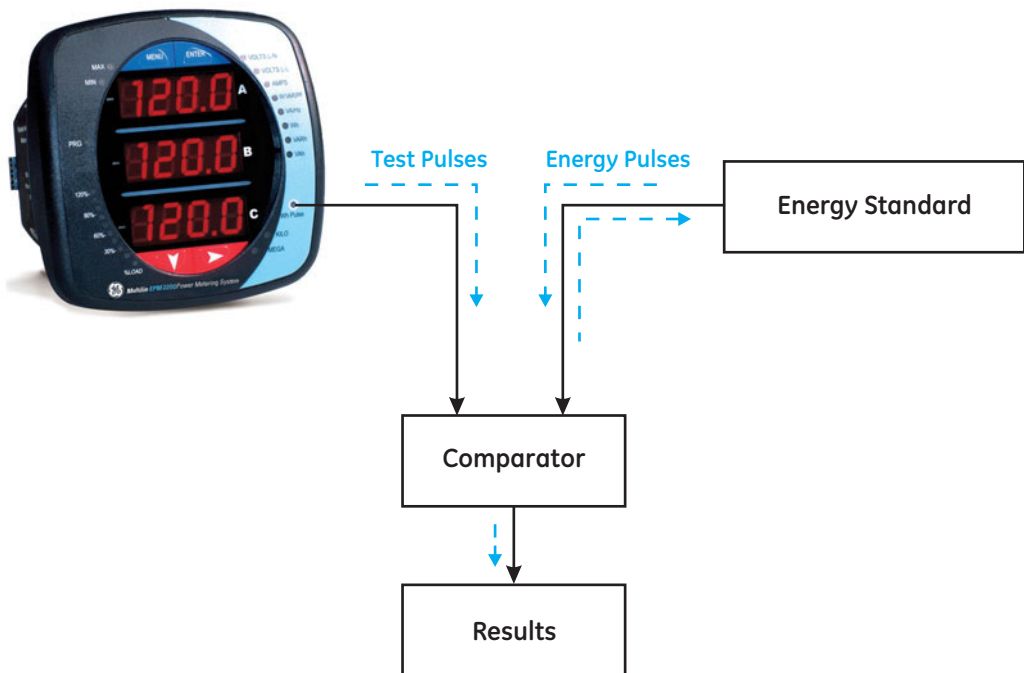

Figure 6-7: Using the Watt-Hour Test Pulse

6.3.1 Infrared & KYZ Pulse Constants for Accuracy Testing

Table 6-3: Infrared & KYZ Pulse Constants for Accuracy Testing

Voltage Level	Class 10 Models
Below 150 V	0.2505759630
Above 150 V	1.0023038521



- Minimum pulse width is 40 ms.
- Refer to *Specifications* on page 2–4 for Wh Pulse specifications.
- The EPM 2200 with Communications Option B: BACnet does not have a KYZ pulse output.

6.4 GE Communicator Programming Overview

The EPM 2200 meter can be programmed either through the buttons on the faceplate or through software. Software programming and communication utilize either the RS485 connection on the back of the meter (Com Option S) or the ethernet port (Com Option B). Once a connection is established, GE Communicator software can be used both to program the meter and to communicate with EPM 2200 slave devices.

6.4.1 Factory Initial Default Settings

You can connect to the EPM 2200 Com Option S in Default communication mode, using the RS485 port. This feature is useful in debugging or if you do not know the meter's programmed settings and want to find them.

When the EPM 2200 is powered up, you have up to 5 seconds to poll the Name Register as shown in the example below: "How to Connect." You will be connected to the meter with the Factory Initial Default Settings. The meter continues to operate with these default settings for 5 minutes. During this time, you can access the meter's Device Profile to ascertain/change meter information. After the 5 minutes have passed, the meter reverts to the programmed Device Profile settings.

Factory Initial Default Settings:

- Baud Rate: 9600
- Address: 001
- Protocol: Modbus RTU



Connecting in Default communication mode does not apply to the EPM 2200 meter with Com Option B.

6.4.2 How to Connect Using GE Communicator Software

1. Open the GE Communicator software.
2. Click the **Connect** button on the tool bar.

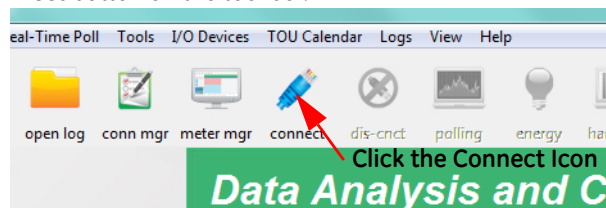

Figure 6-8: Connect Button

3. The Connect screen opens.
 - For Communication Option S (connecting through the RS485 port) make sure your settings are the same as shown here. Use the pull-down windows to make changes, if necessary.

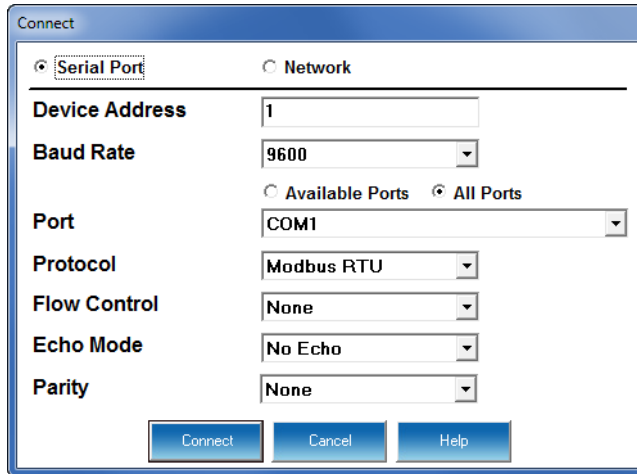

Figure 6-9: Serial Port settings

- For Communication Option B (connecting through the Ethernet port) your settings screen is shown below. Enter the address of the Ethernet card.

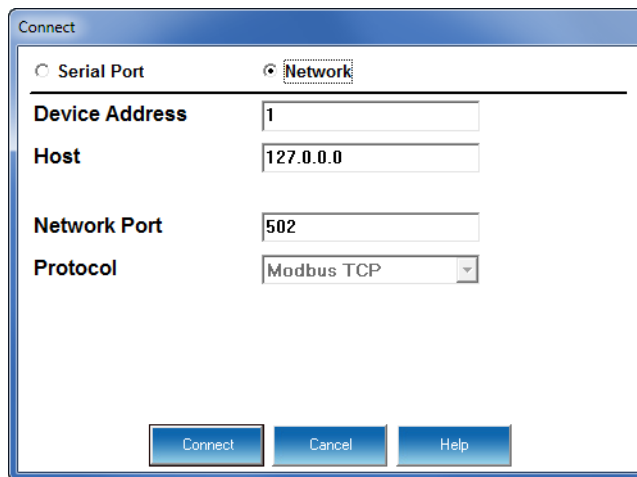

Figure 6-10: Network Port settings

(See 7.3 *Configuring Com Option B: BACnet MS/TP with Modbus TCP/IP* on page 7-4 for Ethernet configuration details.)

4. Click the **Connect** button. If you have a problem connecting, you may have to disconnect power to the meter, then reconnect power and click the **Connect** button, again.

5. You will see the Device Status screen, confirming connection to your meter. Click **OK**.

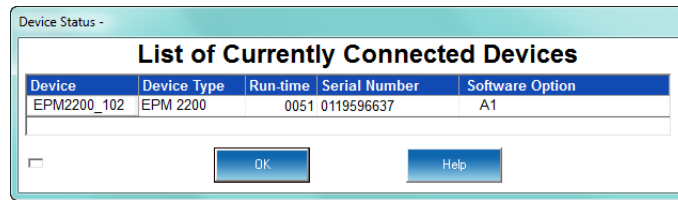
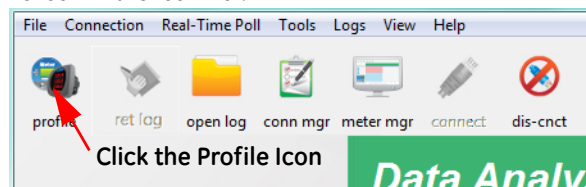
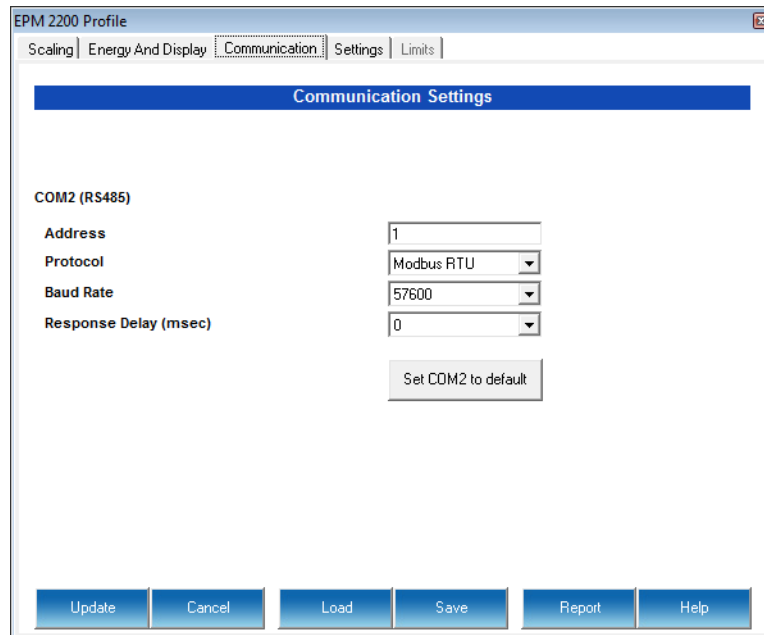

Figure 6-11: Device Status screen

6. Click the Profile icon in the Icon Bar.



7. You will see the Device Profile screen. The tabs at the top of the screen allow you to navigate between setting screens (see below).



8. Click the Communication tab. The Communication Settings appear. Use drop-down menus to change settings of the RS485 port (Com 2) if you have an EPM 2200 meter with Com Option S: RS485/KYZ output.



NOTE

- COM1 is not used by the EPM 2200 meter with Com Option S.
- If you have an EPM 2200 meter with Com Option B (BACnet), the RS485 port is used only for BACnet and is not programmed.

Valid Communication Settings

- **COM2 (RS485)**
 - (1-247)
 - Protocol (Modbus RTU, ASCII)

- Baud Rate (9600 to 57600)
 - Response Delay (0-750 msec)
9. When changes are complete, click **Update** to send a new profile to the meter.
 10. Click **Cancel** to exit the Profile or click other tabs to update other aspects of the Profile (see the next section).

6.4.3 Device Profile Settings

Only the basic Device Profile settings are explained in this manual. Refer to the *GE Communicator Instruction Manual* for details of the meter’s Device Profile.

The Device Profile settings are described in the following sections. After programming the Device Profile, click the options at the bottom of the screen to continue:

- **Update** to send the new Profile to the connected meter.



If the Update fails, the software asks if you want to try to Update again.

- **Cancel** to exit the EPM 2200 Device Profile screen.
- **Load** to load new Device Profile settings from a file.
- **Save** to save the Device Profile settings in a file.
- **Report** to view or print a summary of the Device Profile settings.
- **Help** to view the full *GE Communicator Instruction Manual*



If you click **Cancel** before **Save** or **Update**, you will lose any changes you have made to the Device Profile.

SCALING (CT, PT Ratios and System Wiring)

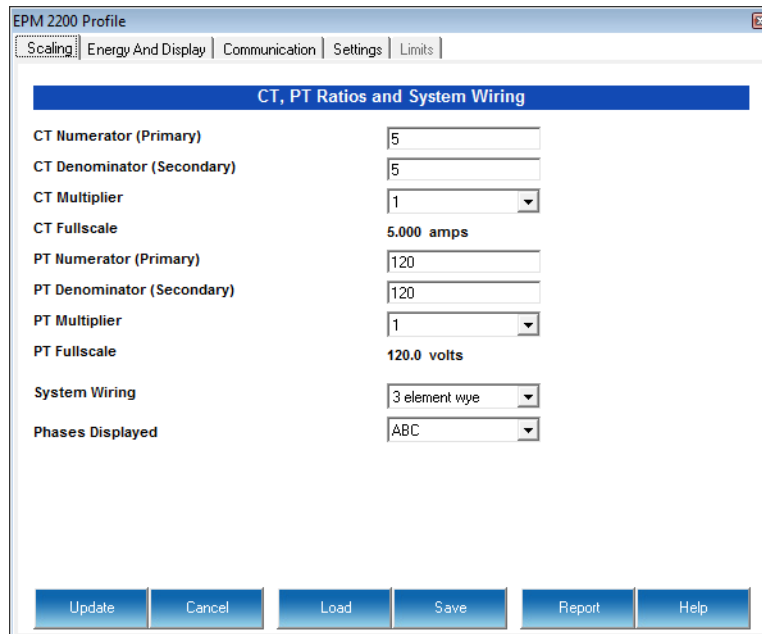

- **CT Numerator (Primary):** 1-9999
- **CT Denominator (Secondary):** 1 or 5 (factory set)
- **CT Multiplier:** 1, 10, or 100
- **CT Fullscale:** Calculation Based on Selections (click Recalculate to view)
- **PT Numerator (Primary):** 1-9999
- **PT Denominator (Secondary):** 40-600
- **PT Multiplier:** 1, 10, 100, or 1000
- **PT Fullscale:** Calculation Based on Selections (click Recalculate to view)
- **System Wiring:** 3 Element Wye; 2.5 Element Wye; 2 CT Delta
- **Phases Displayed:** A, AB, or ABC



NOTE

VOLTS FULL SCALE = PT Numerator x PT Multiplier



WARNING

You must specify Primary and Secondary Voltage in Full Scale. Do not use ratios! The PT Denominator should be the Secondary Voltage level.

Example:

A 14400/120 PT would be entered as:

PT Num: 1440

PT Denom: 120

Multiplier: 10

This example would display a 14.40kV.

Example CT Settings:

200/5 Amps: Set the Ct-n value for 200, Ct-Multiplier value for 1.

800/5 Amps: Set the Ct-n value for 800, Ct-Multiplier value for 1.

2,000/5 Amps: Set the Ct-n value for 2000, Ct-Multiplier value for 1.

10,000/5 Amps: Set the Ct-n value for 1000, Ct-Multiplier value for 10.

Example PT Settings:

277/277 Volts Pt-n value is 277, Pt-d value is 277, Pt-Multiplier is 1.

14,400/120 Volts: Pt-n value is 1440, Pt-d value is 120, Pt-Multiplier value is 10.

138,000/69 Volts: Pt-n value is 1380, Pt-d value is 69, Pt-Multiplier value is 100.

345,000/115 Volts: Pt-n value is 3470, Pt-d value is 115, Pt-Multiplier value is 100

345,000/69 Volts: Pt-n value is 345, Pt-d value is 69, Pt-Multiplier value is 1000.



NOTE

Settings are the same for Wye and Delta configurations.

ENERGY AND DISPLAY

The settings on this screen determine the display configuration of the meter faceplate.

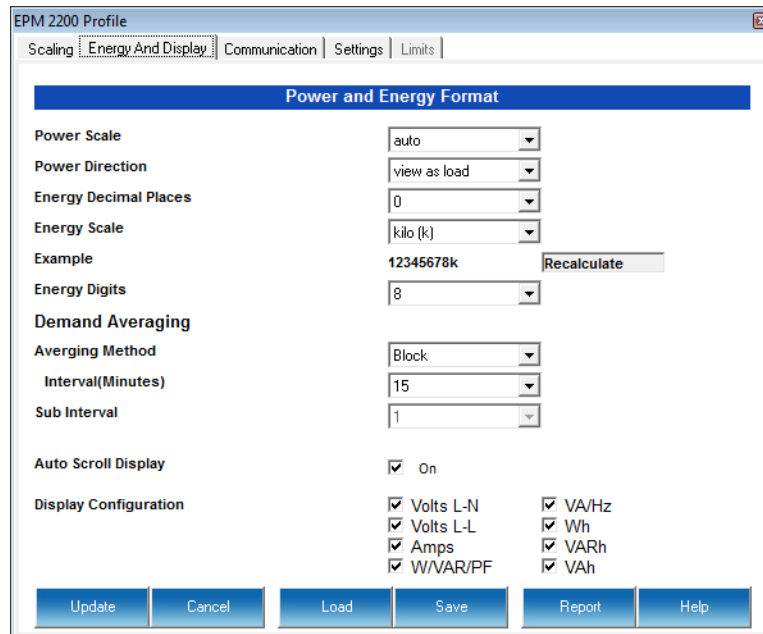

The fields and allowed entries are as follows:

Power and Energy Format

- **Power Scale:** Unit, kilo (k), Mega (M), or auto
- **Energy Digits:** 5, 6, 7, or 8
- **Energy Decimal Places:** 0-6
- **Energy Scale:** Unit, kilo (k), or Mega (M)
- **Example:** Based on Selections (click Recalculate to view)

For Example: a reading for Digits: 8; Decimals: 3; Scale: k would be formatted: 00123.456k

- **Power Direction:** View as Load

Demand Averaging

- **Averaging Method:** Block or Rolling
- **Interval (Minutes):** 5, 15, 30, or 60
- **Sub Interval** (if Rolling is selected): 1-4

Auto Scroll: Click to Activate

Display Configuration:

- Click Values to be displayed.



You MUST have at least ONE Display Configuration value selected.



If incorrect values are entered on the Energy and Display screen the following message appears:

Current, CT, PT and Energy Settings will cause invalid energy accumulator values. Change the inputted settings until the message disappears.

SETTINGS

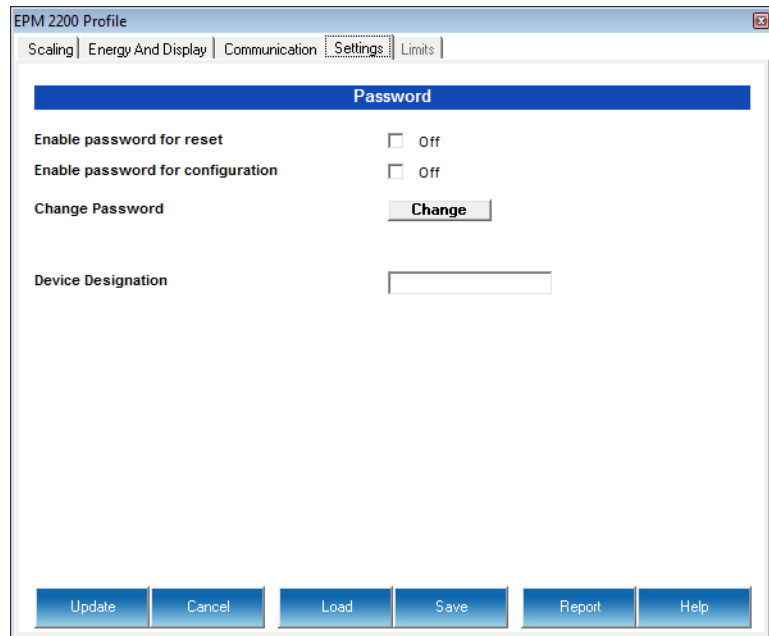

EPM 2200 Profile

Scaling | Energy And Display | Communication | Settings | Limits

Password

Enable password for reset Off

Enable password for configuration Off

Change Password

Device Designation



The EPM 2200 Meter is shipped with Password Disabled; **there is NO DEFAULT PASSWORD**)

The fields are as follows:

- **Enable Password for Reset:** click to enable
- **Enable Password for Configuration:** click to enable
- **Change Password:** click to change
- **Device Designation:** optional user-assigned label

EPM 2200 Power Meter

Chapter 7: Com Option B: BACnet MS/TP with Modbus TCP/IP

The Communication Options available for the EPM 2200 are connected and used in different ways.

- Com Option S: Modbus/KYZ output is explained in Chapter 5 on page 5-1.
- Com Option B: BACnet MS/TP with Modbus TCP/IP Internet is explained in here in Chapter 7.

7.1 BACnet MS/TP

BACnet is a data communication protocol developed for Building Control applications in 1987. BACnet allows applications to process data from many different kinds of equipment and manufacturers. Originally it was used for HVAC control systems, but it has been extended to other building systems, including lighting and energy management. Today BACnet is one of the two most widely used Building Automation protocols in use. It is an ASHRAE/ANSI/ISO standard protocol.

The BACnet protocol consists of Objects that contain different kinds of information. Each Object has properties that contain data related to it. Below is the example of an Object for Total Watts:

- Object_Name, PWR_ELEC
- Object_Type, Analog Input
- Object_Instance, AI-101018
- Present_Value, watt, tot (value in watts)

BACnet operates in a client-server environment. A client machine sends a service request (message) to a server machine; once the service is performed the results are reported back to the client machine. BACnet defines 5 groups (or classes) of 35 message types. For example, one class contains messages for retrieving and manipulating the object properties described above. An example of a common service request in this class is "ReadProperty." When the server machine receives this message from a client machine, it

locates the requested property of the requested object and sends the value to the client. Other classes of service requests have to do with alarms and events; file uploading/downloading; managing remote device operation; and virtual terminal functions.

The EPM 2200 meter communicates BACnet MS/TP protocol through its RS485 serial port, allowing it to act as a BACnet device in any BACnet application. The meter also has a Web interface via its RJ45 Ethernet port that you can use to remotely set up the BACnet MS/TP and for Modbus TCP/IP configuration. The Ethernet port can also track energy readings through the internet using any standard Web browser. The EPM 2200 meter uses BACnet MS/TP (master-slave/token-passing), which is designed to run at speeds of 1 Mbps or less over twisted pair wiring, and in which the device takes turns being a master and a slave, dependent on whether it is sending or receiving data.

For more detailed information, visit the BACnet website at www.bacnet.org.

7.2 EPM 2200 meter BACnet Objects

The EPM 2200 meter BACnet MS/TP implementation has 56 predefined objects of electrical measurements. No programming or mapping is necessary to use the BACnet objects. The object's names easily identify the measurements they contain.

All of the objects, with the exception of Modbus Meter and POLL_DELAY are AI (Analog Input) Object type. The following table lists each of the objects with their units of measurement and description.

Object Name	Unit of Measurement	Description
Modbus Meter-147222	none	(Addr. 1)
POLL_DELAY	AV-1	Polling Delay
VOLTAGE_LN-A	volt	Voltage A-N
VOLTAGE_LN-B	volt	Voltage B-N
VOLTAGE_LN-C	volt	Voltage C-N
VOLTAGE_LL-AB	volt	Voltage A-B
VOLTAGE_LL-BC	volt	Voltage B-C
VOLTAGE_LL-CA	volt	Voltage C-A
CURRENT_LN-A	amp	Current A
CURRENT_LN-B	amp	Current B
CURRENT_LN-C	amp	Current C
PWR_ELEC	watt	Total Active Power
PWR_ELEC_K	kilowatt	Total kWatt
PWR_ELEC_REACT	volt-amp-reactive	Total Reactive Power
PWR_ELEC_REACT_K	kilovolt-amp-reactive	Total kVAR
PWR_ELEC_APPAR	volt-amp	Total Apparent Power

Object Name	Unit of Measurement	Description
PWR_ELEC_APPAR_K	kilovolt-amp	Total kVA
PWR_FACTOR	---	Total Power Factor
FREQUENCY	Hertz	Frequency
CURRENT_NG	amp	Neutral Current
ENERGY_ELEC_ACCUM_REC*	watt-hour	Active Energy Received
ENERGY_ELEC_ACCUM_REC_K	kilowatt-hour	kWh Received
ENERGY_ELEC_ACCUM_DEL*	watt-hour	Active Energy Delivered
ENERGY_ELEC_ACCUM_DEL_K	kilowatt-hour	kWh Delivered
ENERGY_ELEC_ACCUM_NET*	watt-hour	Active Energy Net
ENERGY_ELEC_ACCUM_NET_K	kilowatt-hour	kWh Net
ENERGY_ELEC_ACCUM*	watt-hour	Total Active Energy
ENERGY_ELEC_ACCUM_K	kilowatt-hour	Total kWh
ENERGY_ELEC_ACCUM_REACT_REC*	volt-amp-hours-reactive	Positive Reactive Energy
ENERGY_ELEC_ACCUM_REACT_REC_K	kilovolt-amp-hours-reactive	Positive kVARh
ENERGY_ELEC_ACCUM_REACT_DEL*	volt-amp-hours-reactive	Negative Reactive Energy
ENERGY_ELEC_ACCUM_REACT_DEL_K	kilovolt-amp-hours-reactive	Negative kVARh
ENERGY_ELEC_ACCUM_REACT_NET*	volt-amp-hours-reactive	Reactive Energy Net
ENERGY_ELEC_ACCUM_REACT_NET_K	kilovolt-amp-hours-reactive	kVARh Net
ENERGY_ELEC_ACCUM_REACT*	volt-amp-hours-reactive	Total Reactive Energy
ENERGY_ELEC_ACCUM_REACT_K	kilovolt-amp-hours-reactive	Total kVARh
ENERGY_ELEC_ACCUM_APPAR*	volt-amp-hours	Total Apparent Energy
ENERGY_ELEC_ACCUM_APPAR_K	kilovolt-amp-hours	Total kVAh
DEMAND_POS	watt	Positive Active Demand, 3-Phase, Average Demand
DEMAND_POS_K	kilowatt	Positive kW, 3-Phase Average Demand
DEMAND_REACT_POS	volt-amp-reactive	Positive Reactive Demand, 3-Phase, Average Demand
DEMAND_REACT_POS_K	kilovolt-amp-reactive	Positive kVAR, 3-Phase, Average Demand
DEMAND_NEG	watt	Negative Active Demand, 3-Phase, Average Demand
DEMAND_NEG_K	kilowatt	Negative kW, 3-Phase, Average Demand

Object Name	Unit of Measurement	Description
DEMAND_REACT_NEG	volt-amp-reactive	Negative Reactive Demand, 3-Phase, Average Demand
DEMAND_REACT_NEG_K	kilovolt-amp-reactive	Negative kVAR, 3-Phase, Average Demand
DEMAND_APPAR	volt-amp	Apparent Demand, 3-Phase, Average Demand
DEMAND_APPAR_K	kilovolt-amp	kVA, 3-Phase, Average Demand
DEMAND_PEAK_POS	watt	Positive Active Demand, 3-Phase, Max Average Demand
DEMAND_PEAK_POS_K	kilowatt	Positive kW, 3-Phase Max Average Demand
DEMAND_REACT_PEAK_POS	volt-amp-reactive	Positive Reactive Demand, 3-phase, Max Average Demand
DEMAND_REACT_PEAK_POS_K	kilovolt-amp-reactive	Positive kVAR, 3-Phase, Max Average Demand
DEMAND_PEAK_NEG	watt	Negative Active Demand, 3-Phase, Max Average Demand
DEMAND_PEAK_NEG_K	kilowatt	Negative kW, 3-Phase, Max Average Demand
DEMAND_REACT_PEAK_NEG	volt-amp-reactive	Negative Reactive Demand, 3-Phase, Max Average Demand
DEMAND_REACT_PEAK_NEG_K	kilovolt-amp-reactive	Negative kVAR, 3-Phase, Max Average Demand
DEMAND_APPAR_PEAK	volt-amp	Apparent Demand, 3-Phase, Max Average Demand
DEMAND_APPAR_PEAK_K	kilovolt-amp	kVA, 3-Phase, Max Average Demand

* For optimal accuracy and resolution the accumulators’ attributes are factory preset to: 6 digits, no fractions – zero decimal places and kilo multiplier (Modbus register address: 30,006, decimal). We recommended you maintain these settings all of the time.

7.3 Configuring Com Option B: BACnet MS/TP with Modbus TCP/IP

You must first set the Network configuration so you can communicate with the EPM 2200 meter. Follow these steps:

1. Configure your LAN connection to IP address 10.0.0.100, subnet mask 255.255.255.0:

- Click **Start > Control Panel > Network Connections**.
You will see a screen like the one shown below.

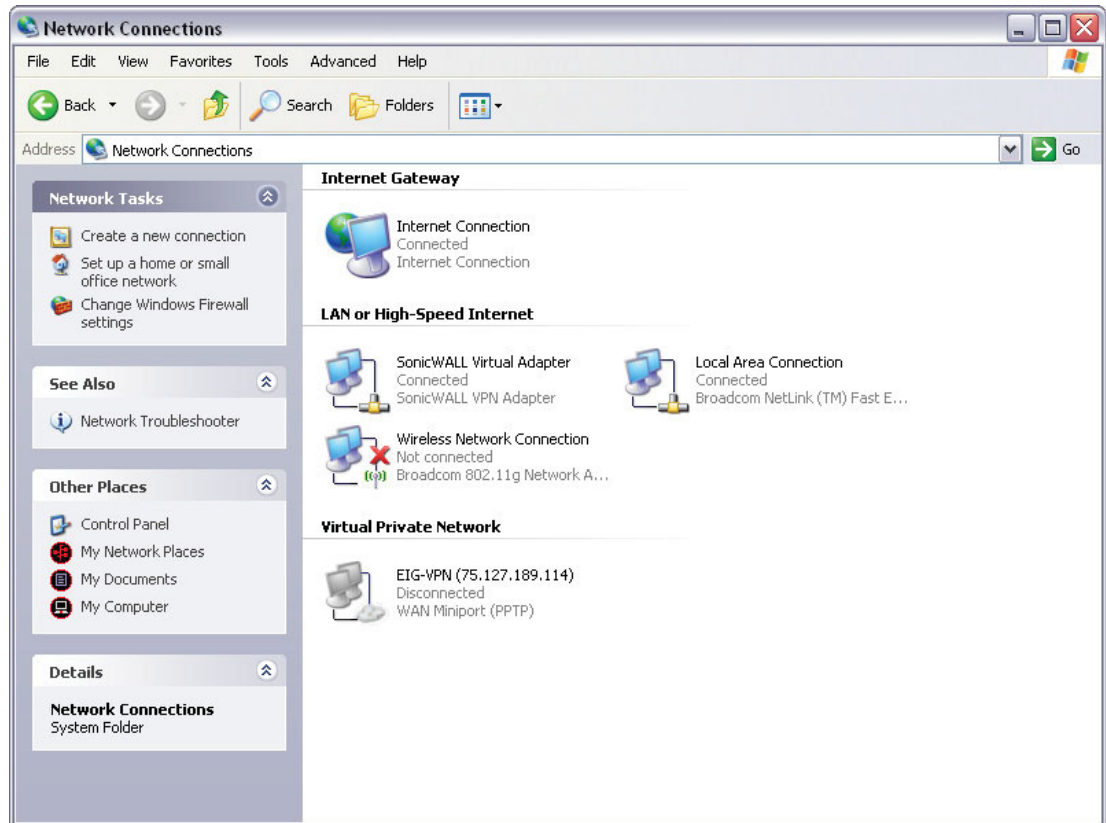

- Right-click on the LAN connection you want to use and click **Properties**. You will see the screen shown below.

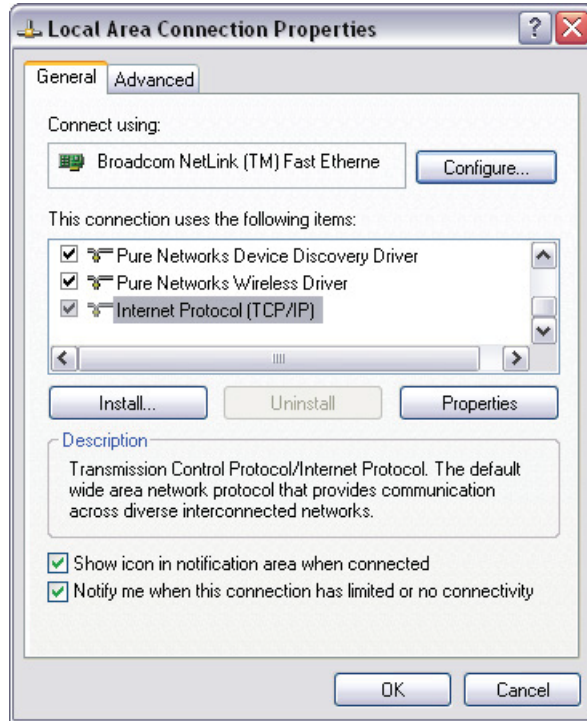

- Scroll and highlight Internet Protocol TCP/IP, then click the **Properties** button. You will see the screen shown below.

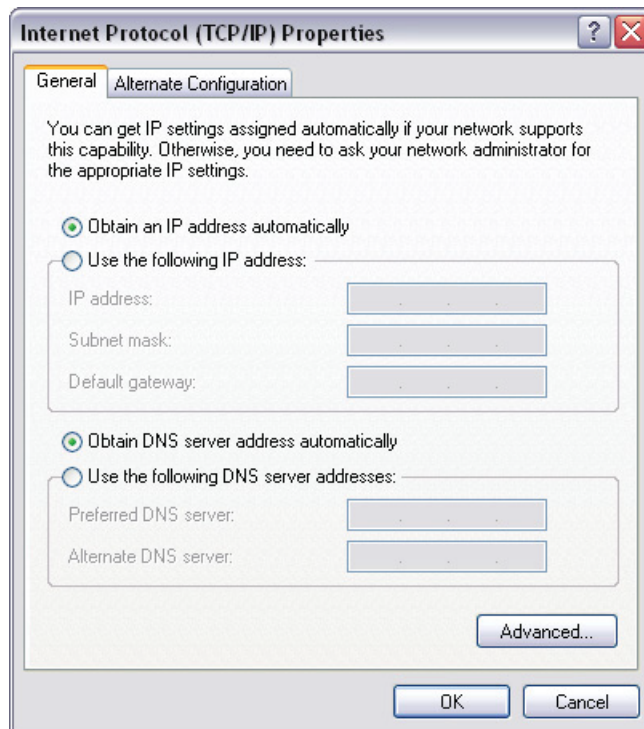

- Click the **Use the Following IP Address** radio button and enter:
 - IP Address: 10.0.0.100
 - Subnet Mask: 255.255.255.0
 - Click **OK**.
The Local Area Connection Properties screen redisplay.
 - Click **OK**.
2. Use an Ethernet cable to connect the meter to your LAN port.

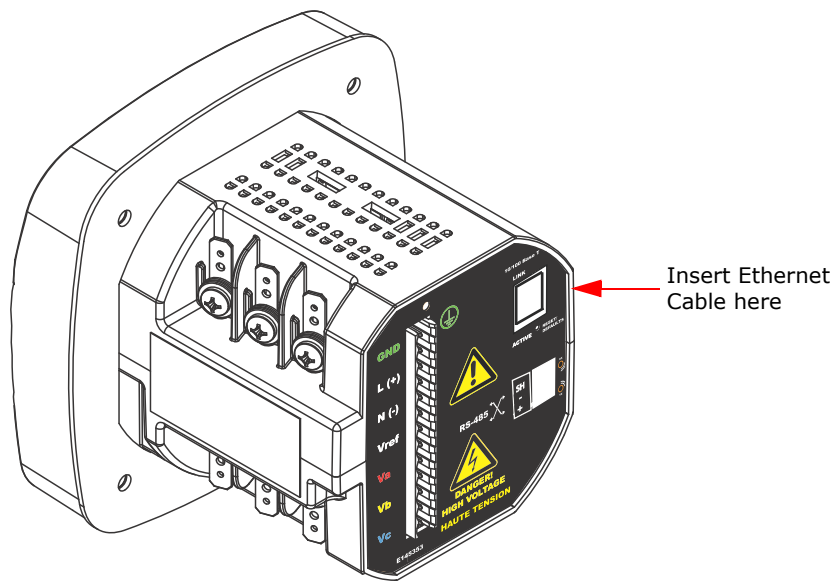

3. Open your web browser and connect to the meter at the default address by typing <http://10.0.0.1>.



NOTE

If this doesn't work, reset the meter to this default address by pressing the Reset button for 30 seconds. See "Resetting the Ethernet Card" on page 11 for instructions.

4. You will see a User Authentication screen. Enter the following default settings:
- User name: admin
 - Password: admin

5. Click **OK**. You will see the BACnet MS/TP Interface webpage, shown below.

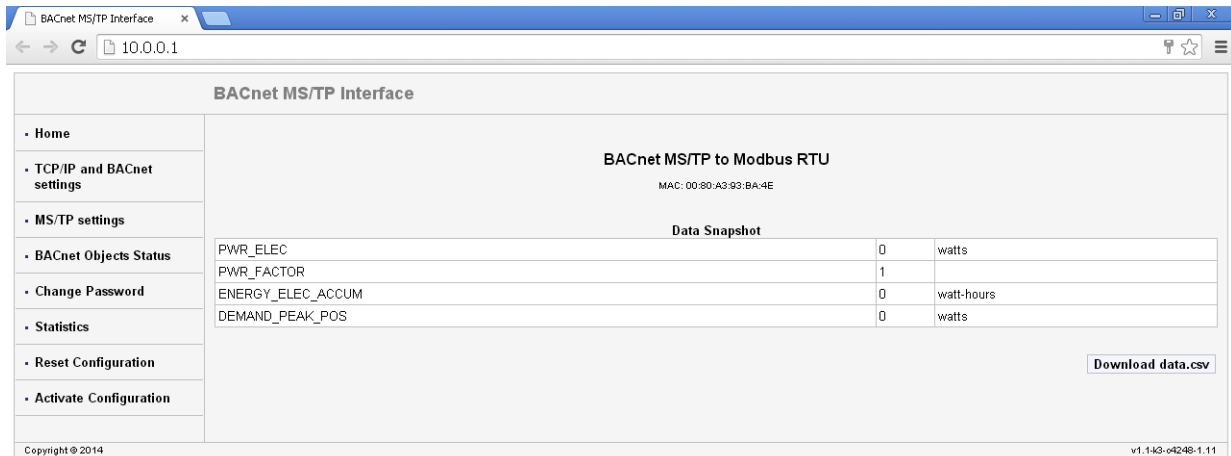

6. Click **TCP/IP** and **BACnet Settings** on the left side of the webpage to see the page shown below. Use this page to change the default IP address (10.0.0.1) to an IP address in the same subnet as your Network. Contact your System Administrator if you are unsure of the correct address to use.

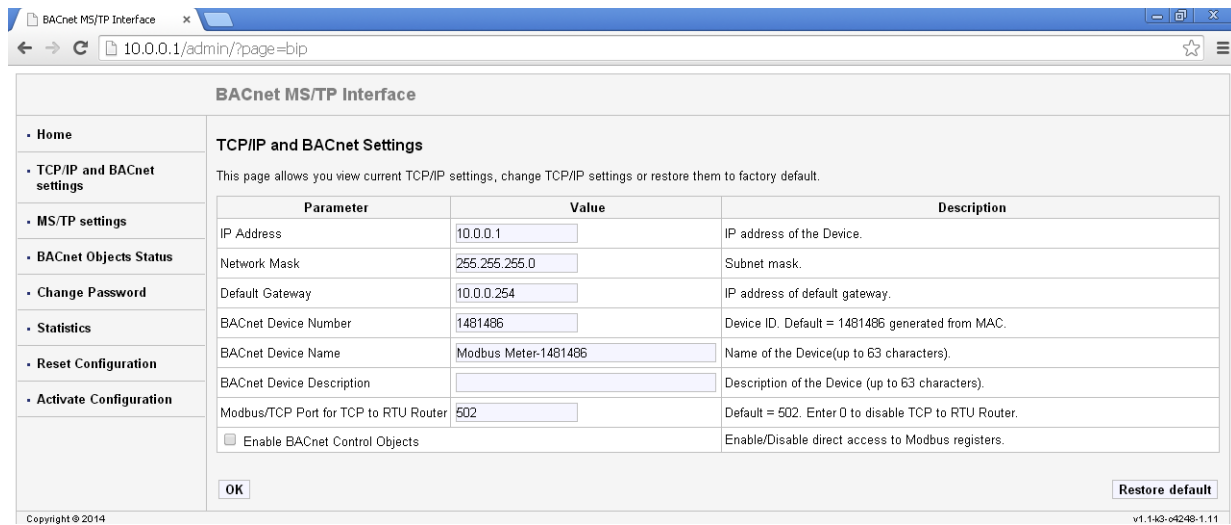

You can also change the following fields:

- **Network Mask** - the subnet mask. The default is 255.255.255.0.
- **Default Gateway** - the IP address of the gateway. The default is 10.0.0.224.
- **BACnet Device Number** - a numeric code used to identify the meter. This number is auto-generated from the MAC address.
- **BACnet Device Name** - field for the device name, which can be up to 63 characters in length.
- **BACnet Device Description** - optional field where you can enter a description of up to 63 characters which will be added as a prefix in the name of all registers representing the meter's BACnet objects.

- **Modbus TCP Port for TCP to RTU Router** - the default port is 502. As long as this field is not 0, the router is enabled, which lets the meter communicate with Modbus TCP/IP Master devices.
- **Enable BACnet/IP Control Objects** - Check this box to allow direct access to Modbus registers. If enabled, the Control Objects are represented by the following three Analog-Value BACnet Objects:
 - **500001** is a writable object called MOD_ID_TARGET (“target device identifier to be read/written”). Since the meter has a hard-coded Modbus address of “1” only this value needs to be entered before first access to a Modbus register. The default = -1.0. -1.0 also means do not execute #500003 (neither read nor write).
 - **500002** is a writable object called MOD_REGISTER (“register to be read/written”); for example, “1000” to access the first register of volts A-N. The default = -1.0 after any reboot. -1.0 also means do not execute #500003 (neither read nor write).
 - **500003** is a readable/writable value called MOD_VALUE (“value to be read from or written to select register”).

The MOD_REGISTER resets with -1.0 after each Read/Write (whether or not successful), from/to MOD_VALUE with valid MOD_ID_TARGET and MOD_REGISTER. MOD_REGISTER will also be set to -1.0 30 seconds after it is written to.

7. Click **OK** to process your changes. You will see the following message

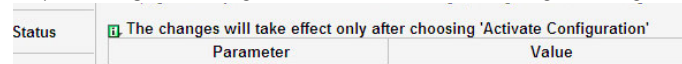

You still need to activate the configuration for the changes to take effect.



You can change all settings back to their default by clicking the **Restore Default** button at the bottom of the page.

8. Click **MS/TP Settings** on the left side of the webpage to see the page shown below. Use this page to make any necessary changes to your MS/TP settings.

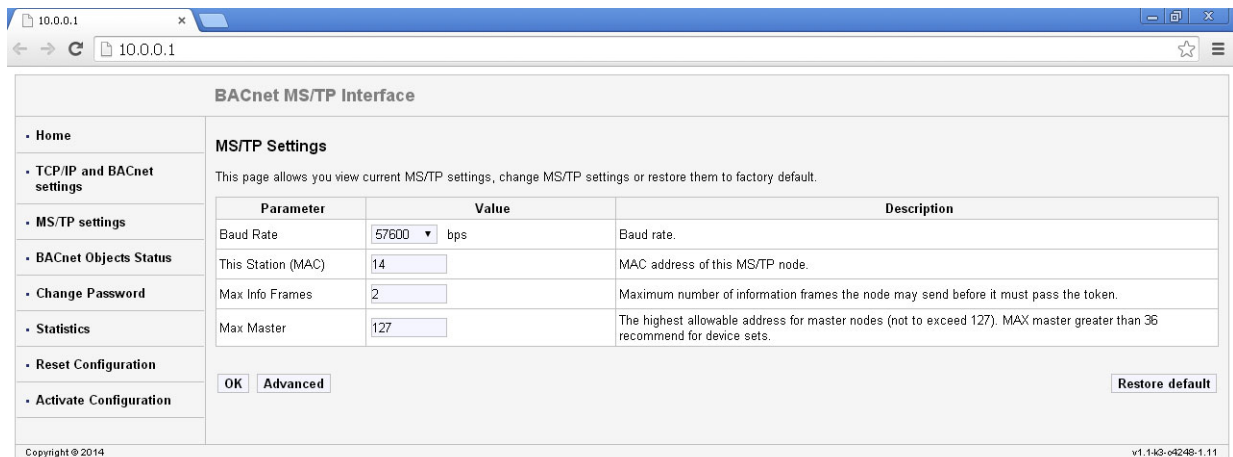

You can change the following fields:

- **Baud Rate** - select the baud rate you need from the pull-down menu.
- **This station (MAC)** - the MAC address of this MS/TP node (the EPM 2200 meter).

- **Max Info Frames** - this is the maximum number of information frames the node is allowed to send before it needs to pass the token.
 - **Max Master** - this is the highest allowable address for master nodes (cannot be higher than 127); a Max master greater than 36 is recommended for data sets.
9. Click the Advanced button to display additional settings.



We recommend you do not change any Advanced settings.

10. Click **OK** to process your changes.
11. Click **Activate Configuration** from the left side of the webpage to implement any changes you made. You will see the page shown below.



12. Click the Confirm button to process the changes. You will see the message shown below (the IP Address shown in the link is just an example).

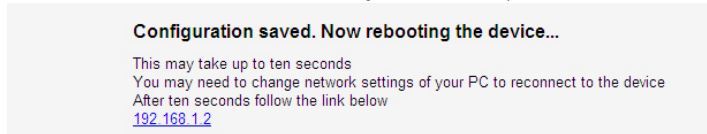

13. The meter resets. Connect the meter Ethernet cable to your Network (remove it from your PC). You can now connect to the meter through your Network using the new IP address.

7.3.1 Resetting the Ethernet Card

The Ethernet card's Reset Button is accessed from the back of the EPM 2200 meter. See figure below for button location.

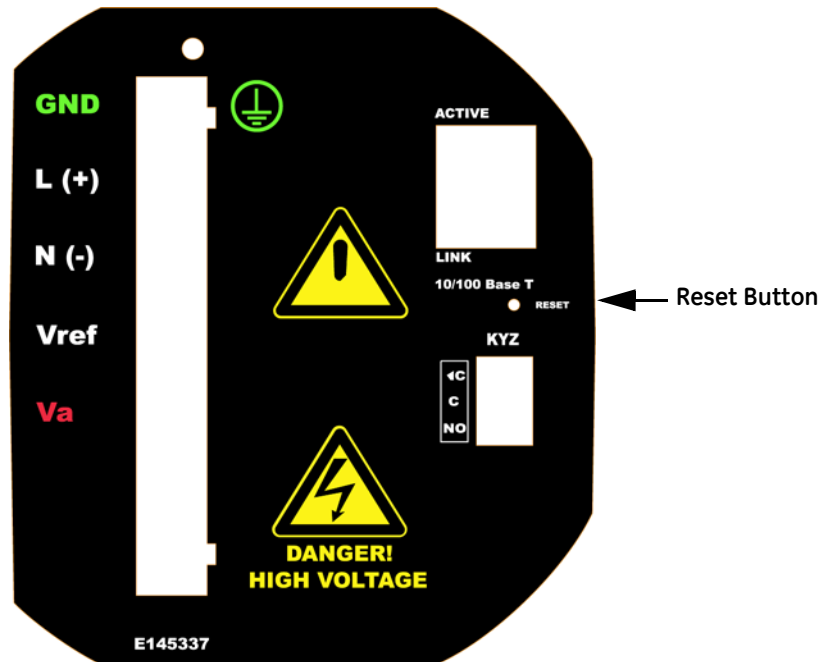

Figure 7-1: Backplate of EPM 2200 meter, showing Reset Button placement

Using an implement such as a ballpoint pen tip, press and hold the Reset button for 30 seconds. The Ethernet card will be reset to its default settings.

7.4 Using the EPM 2200 Meter's Web Interface

As shown in Section 7.3, you can use the meter's web interface to change the IP address and other Network parameters. You can also view information and readings using the web interface. This section explains the web pages other than the BACnet MS/TP Settings and Activate Configuration web pages, which are explained in Section 7.3.

7.4.1 Home web page

The Home web page is shown at the top of page 7-8. It is the first page you see when you connect to the meter.



To access this web page from any of the other pages, click **Home** on the left side of the page.

This web page shows the current power, power factor, accumulated energy, and peak demand readings from the meter. You can download all of the meter BACnet data by clicking the **Download data.csv** button. You will see the following screen:

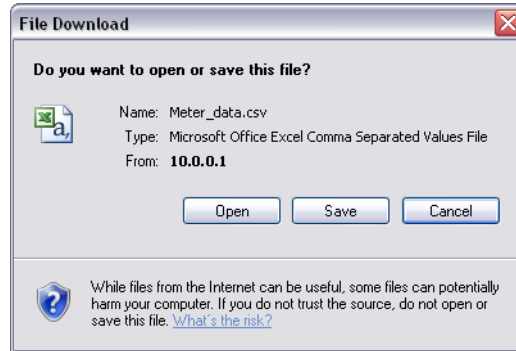

This screen gives you the option to open or save an Excel file with the BACnet meter data.

- Click **Open** to open an Excel file with the meter’s BACnet data.
- Click **Save** to save a copy of the Excel file.
- Click **Cancel** to close the screen without opening or saving the file.

An example file is shown below:

Name	Object	Value	Units	Reliable	Description
VOLTAGE_AI-1000		0	volts	yes	Volts A-N
VOLTAGE_AI-1002		0	volts	yes	Volts B-N
VOLTAGE_AI-1004		0	volts	yes	Volts C-N
VOLTAGE_AI-1006		0	volts	yes	Volts A-B
VOLTAGE_AI-1008		0	volts	yes	Volts B-C
VOLTAGE_AI-1010		0	volts	yes	Volts C-A
CURRENT_AI-1012		0	amperes	yes	Amps A
CURRENT_AI-1014		0	amperes	yes	Amps B
CURRENT_AI-1016		0	amperes	yes	Amps C
PWR_ELEC_AI-1018		0	watts	yes	Watts,tot
PWR_ELEC_AI-11018		0	kilowatts	yes	kWatts,tot
PWR_ELEC_AI-1020		0	volt-amp	yes	VARs,tot
PWR_ELEC_AI-11020		0	kilovolt-ai	yes	kVARs,tot
PWR_ELEC_AI-1022		0	volt-amp	yes	VAs,tot
PWR_ELEC_AI-11022		0	kilovolt-ai	yes	kVAs,tot
PWR_FAC_AI-1024		0	-	yes	PF,tot
FREQUEN_AI-1026		0	hertz	yes	Frequency
CURRENT_AI-1028		0	amperes	yes	Current N
ENERGY_E_AI-1100		12655.27	watt-hour	yes	Wh, Rec
ENERGY_E_AI-11100		12.65527	kilowatt-h	yes	kWh, Rec
ENERGY_E_AI-1102		-17.917	watt-hour	yes	Wh, Del
ENERGY_E_AI-11102		-0.01792	kilowatt-h	yes	kWh, Del
ENERGY_E_AI-1104		12637.35	watt-hour	yes	Wh,Net
ENERGY_E_AI-11104		12.63735	kilowatt-h	yes	kWh,Net
ENERGY_E_AI-1106		12673.18	watt-hour	yes	Wh,Tot
ENERGY_E_AI-11106		12.67318	kilowatt-h	yes	kWh,Tot
ENERGY_E_AI-1108		303.204	volt-amp	yes	VARh,Pos
ENERGY_E_AI-11108		0.303204	kvolt-amp	yes	kVARh,Pos
ENERGY_E_AI-1110		-87.922	volt-amp	yes	VARh,Neg
ENERGY_E_AI-11110		-0.08792	kvolt-amp	yes	kVARh,Neg
ENERGY_E_AI-1112		215.281	volt-amp	yes	VARh,Net
ENERGY_E_AI-11112		0.215281	kvolt-amp	yes	kVARh,Net
ENERGY_E_AI-1114		391.126	volt-amp	yes	VARh,Tot

7.4.2 BACnet Objects Status web page

- Click **BACnet Objects Status** on the left side of the web page to view readings for the meter's embedded BACnet objects. You will see a screen like the one shown below.

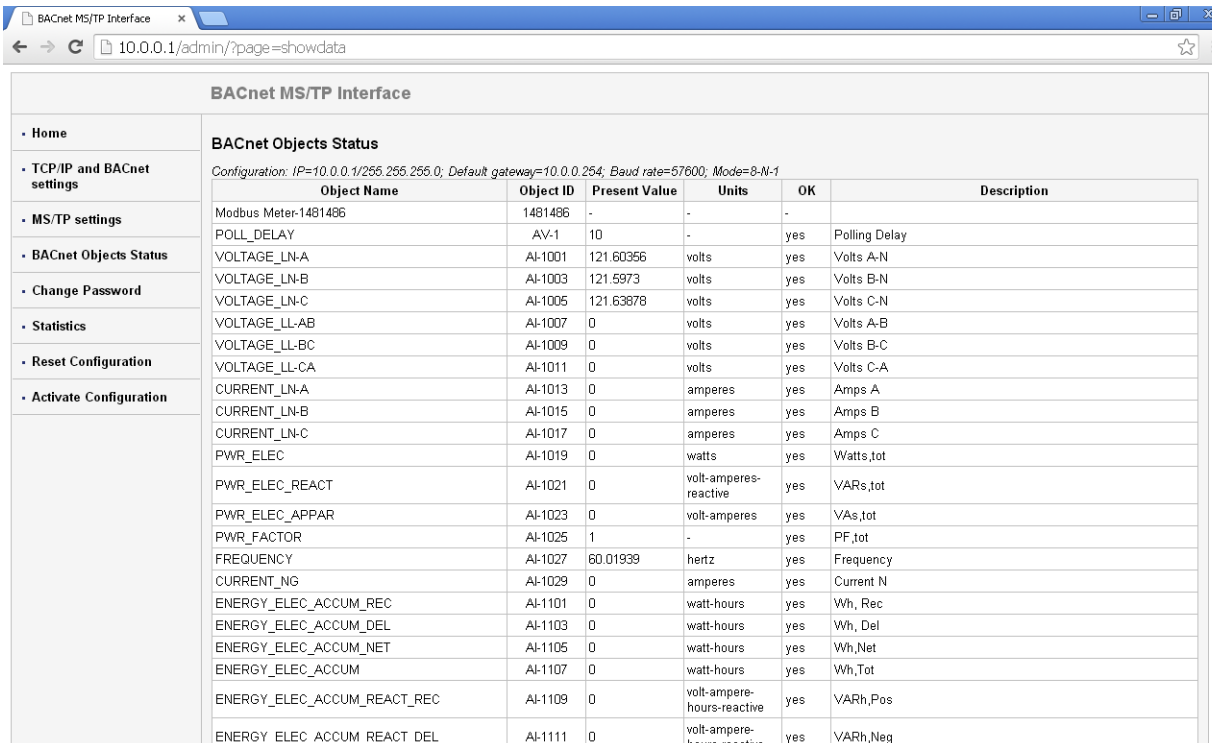

The screenshot shows a web browser window titled "BACnet MS/TP Interface" with the URL "10.0.0.1/admin/?page=showdata". The page content includes a navigation menu on the left and a main table of BACnet objects.

BACnet MS/TP Interface						
• Home	BACnet Objects Status					
• TCP/IP and BACnet settings	Configuration: IP=10.0.0.1/255.255.255.0; Default gateway=10.0.0.254; Baud rate=57600; Mode=9-N-1					
• MS/TP settings	Object Name	Object ID	Present Value	Units	OK	Description
• BACnet Objects Status	Modbus Meter-1481486	1481486	-	-	-	
• Change Password	POLL_DELAY	AV-1	10	-	yes	Polling Delay
• Statistics	VOLTAGE_LN-A	AI-1001	121.60356	volts	yes	Volts A-N
• Reset Configuration	VOLTAGE_LN-B	AI-1003	121.5973	volts	yes	Volts B-N
• Activate Configuration	VOLTAGE_LN-C	AI-1005	121.63878	volts	yes	Volts C-N
	VOLTAGE_LL-AB	AI-1007	0	volts	yes	Volts A-B
	VOLTAGE_LL-BC	AI-1009	0	volts	yes	Volts B-C
	VOLTAGE_LL-CA	AI-1011	0	volts	yes	Volts C-A
	CURRENT_LN-A	AI-1013	0	amperes	yes	Amps A
	CURRENT_LN-B	AI-1015	0	amperes	yes	Amps B
	CURRENT_LN-C	AI-1017	0	amperes	yes	Amps C
	PWR_ELEC	AI-1019	0	watts	yes	Watts,tot
	PWR_ELEC_REACT	AI-1021	0	volt-amperes-reactive	yes	VARs,tot
	PWR_ELEC_APPAR	AI-1023	0	volt-amperes	yes	VA,tot
	PWR_FACTOR	AI-1025	1	-	yes	PF,tot
	FREQUENCY	AI-1027	60.01939	hertz	yes	Frequency
	CURRENT_NG	AI-1029	0	amperes	yes	Current N
	ENERGY_ELEC_ACCUM_REC	AI-1101	0	watt-hours	yes	Wh, Rec
	ENERGY_ELEC_ACCUM_DEL	AI-1103	0	watt-hours	yes	Wh, Del
	ENERGY_ELEC_ACCUM_NET	AI-1105	0	watt-hours	yes	Wh,Net
	ENERGY_ELEC_ACCUM	AI-1107	0	watt-hours	yes	Wh,Tot
	ENERGY_ELEC_ACCUM_REACT_REC	AI-1109	0	volt-ampere-hours-reactive	yes	VARh,Pos
	ENERGY_ELEC_ACCUM_REACT_DEL	AI-1111	0	volt-ampere-hours-reactive	yes	VARh,Neg

Scroll to see all of the objects on the screen. The following items are shown for each BACnet Object:

- **Name**
- **Object**
- **Value**
- **Units**
- **OK (Reliability)**
- **Description**

7.4.3 Change Password web page

- Click **Change Password** on the left side of the web page to access the page shown below.



Use this page to change the Administrator Login and Password for this interface. We recommend that you change the Login and Password rather than continuing to use the default sign-on (be sure to store this information someplace safe).

7.4.4 Statistics web page

- Click **Statistics** on the left side of the web page to access the page shown below.



This page lists information and any Error log for the meter.

- To erase the Error log, click the **Clear Log** button.

7.4.5 Reset Configuration web page

- Click **Reset Configuration** on the left side of the web page if you want to set the configuration back to its default or last configuration. You will see the page shown below.

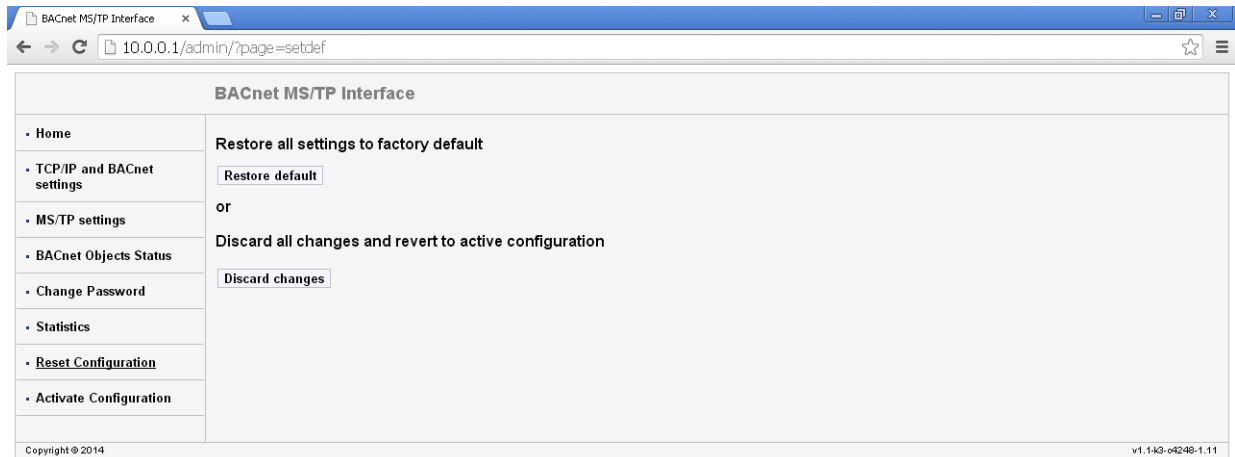

- Click the **Restore Default** button to restore all settings to the factory default values.
- Click the **Discard Changes** button to restore all settings to the last saved configuration.

7.5 Using the EPM 2200 in a BACnet Application

Once you have configured the EPM 2200 meter, you can connect the RS485 port to your BACnet implementation and use it as a standard BACnet client. As there are many kinds of BACnet applications, we recommend you consult your application's instructions for details.

In addition to integrating with BACnet applications, the EPM 2200 meter can also be accessed through GE Communicator software (see the *GE Communicator Instruction Manual*). Additionally, all of the BACnet data can be polled through the Modbus registers (see Appendix B: "Modbus Mapping for EPM 2200" on page 1 for the Modbus map).

EPM 2200 Power Meter

Appendix A: EPM 2200 Navigation Maps

A.1 Introduction

The EPM 2200 meter can be configured and a variety of functions performed using the buttons on the meter face.

- An Overview of the Elements and Buttons on the meter face, and programming using the buttons can be found in Chapter 6 on page 6-1.
- The meter can also be programmed using software (see the *GE Communicator Instruction Manual*).

A.2 Navigation Maps (Sheets 1 to 4)

The EPM 2200 Navigation Maps begin on the next page.

They show in detail how to move from one screen to another and from one Display Mode to another using the buttons on the face of the meter. All Display Modes will automatically return to Operating Mode after 10 minutes with no user activity.

A.2.1 EPM 2200 Navigation Map Titles:

Main Menu Screens (Sheet 1)

Operating Mode Screens (Sheet 2)

Reset Mode Screens (Sheet 3)

Configuration Mode Screens (Sheet 4)

Figure A-1: Main Menu Screens (Sheet 1)

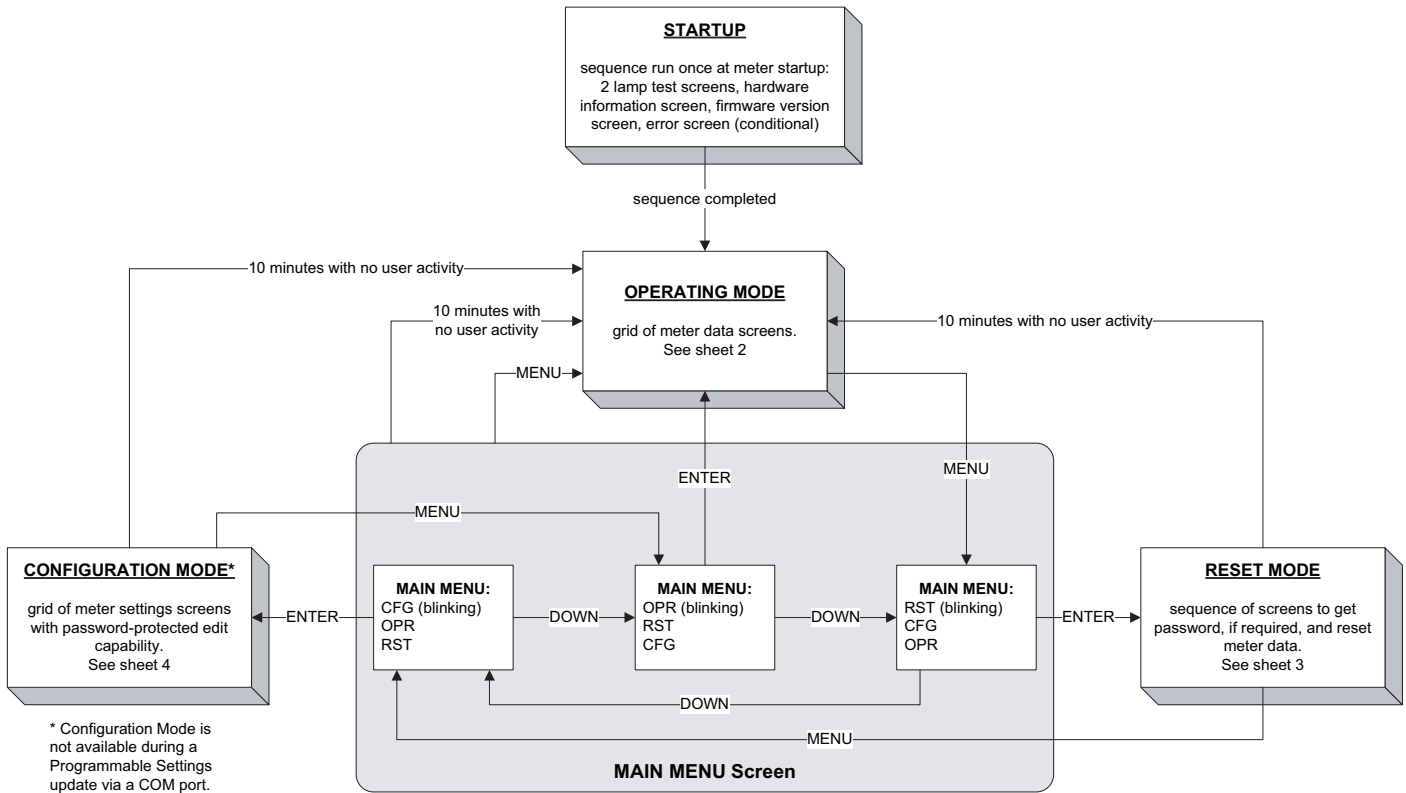

MAIN MENU screen scrolls through 3 choices, showing all 3 at once. The top choice is always the "active" one, which is indicated by blinking the legend.

BUTTONS	
MENU	Returns to previous menu from any screen in any mode
ENTER	Indicates acceptance of the current screen and advances to the next one
DOWN, RIGHT	Navigation and edit buttons
Navigation:	No digits or legends are blinking. On a menu, down advances to the next menu selection, right does nothing. In a grid of screens, down advances to the next row, right advances to the next column. Rows, columns, and menus all navigate circularly.
Editing:	A digit or legend is blinking to indicate that it is eligible for change. When a digit is blinking, down increases the digit value, right moves to the next digit. When a legend is blinking, either button advances to the next choice legend.



Figure A-2: Operating Mode Screens (Sheet 2)

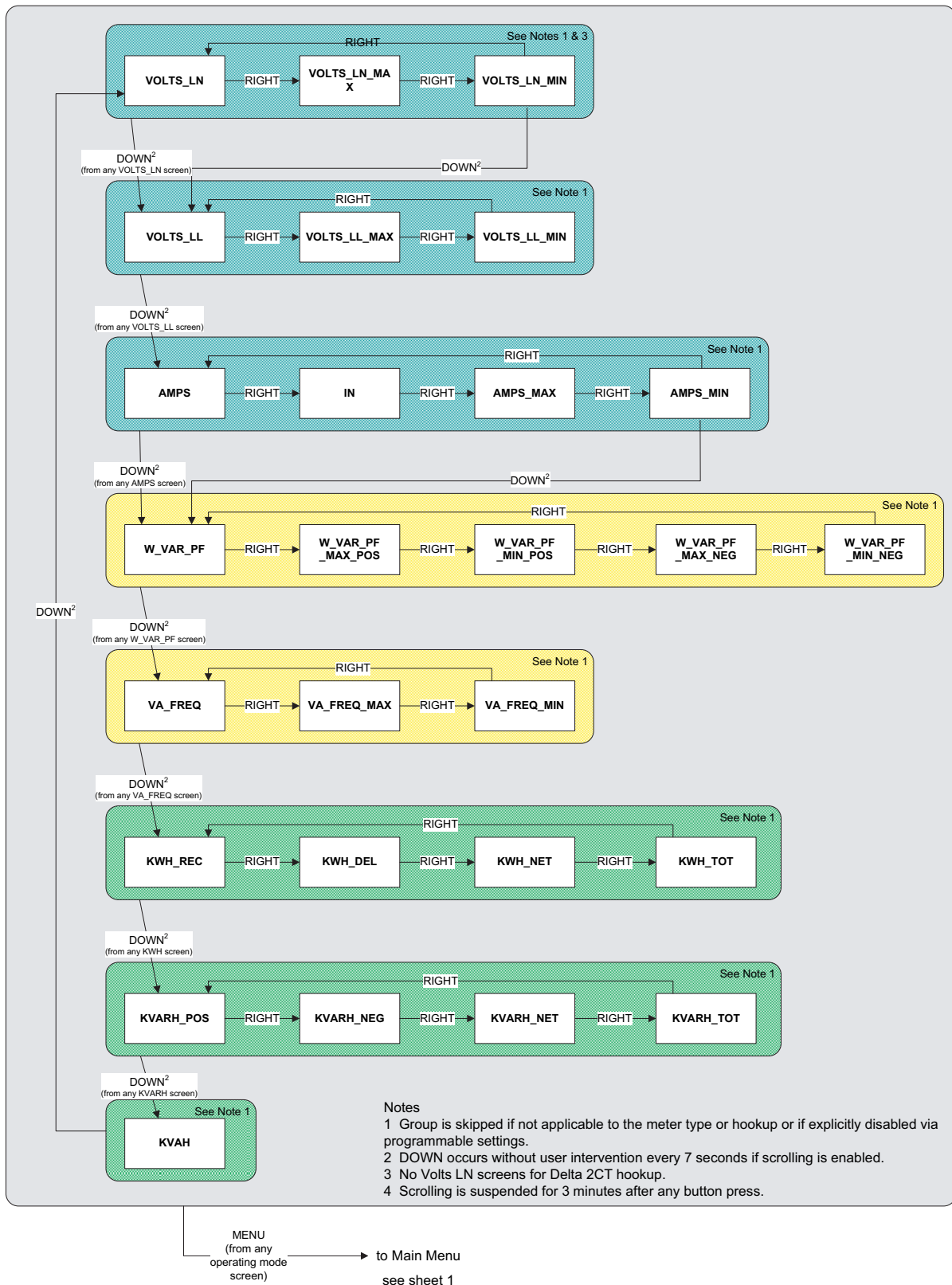

Figure A-3: Reset Mode Screens (Sheet 3)

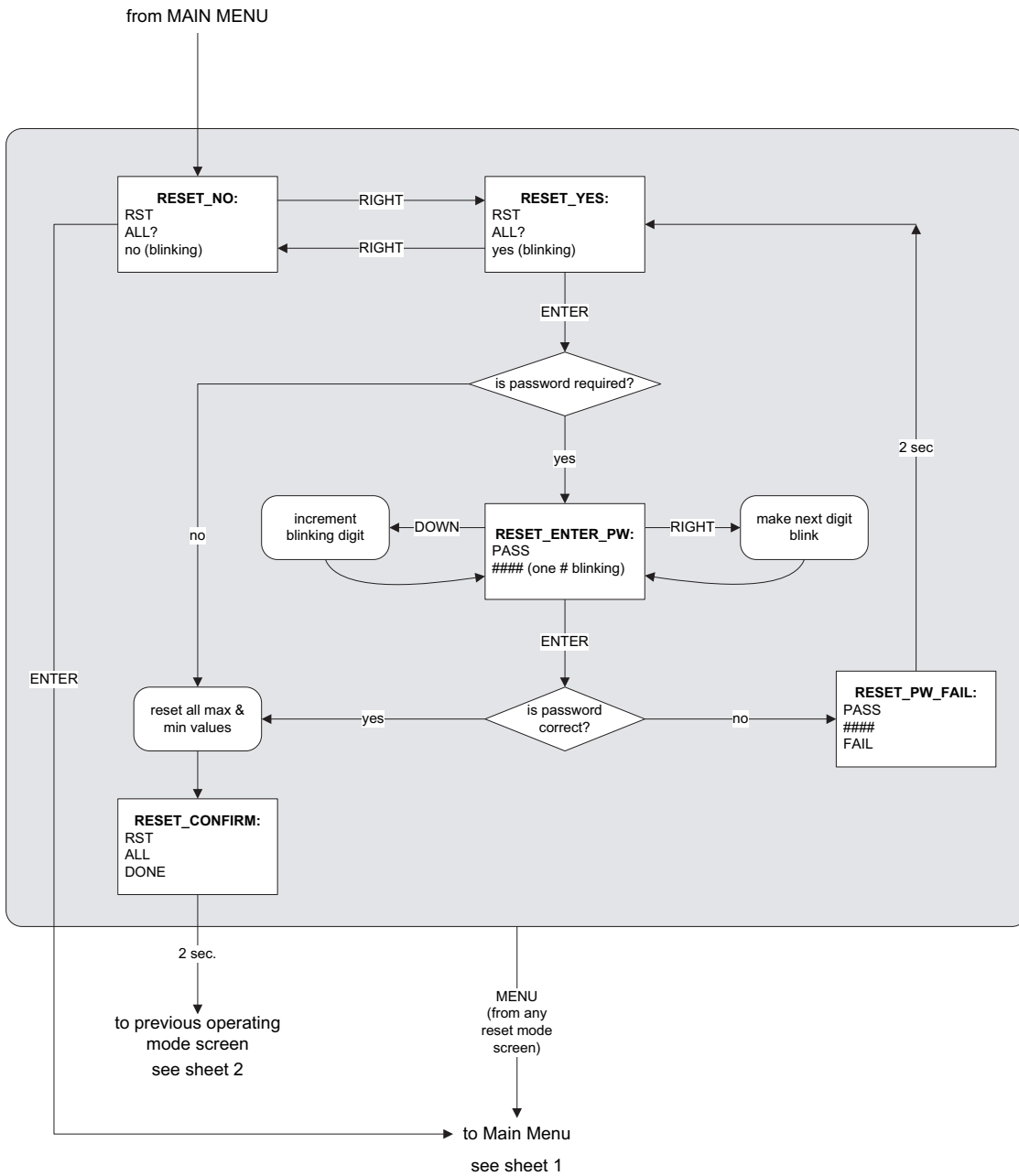
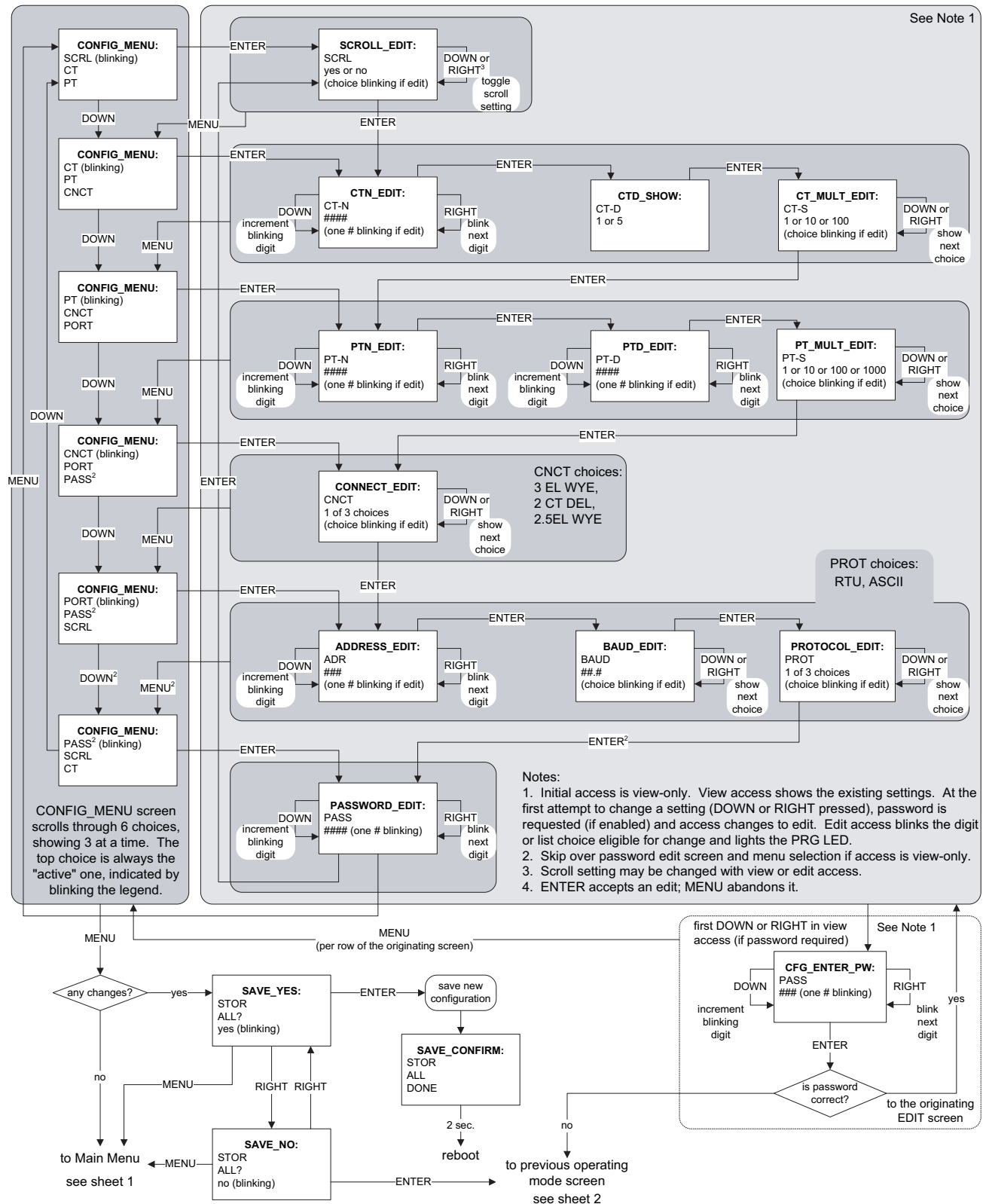

Figure A-4: Configuration Mode Screens (Sheet 4)



EPM 2200 Power Meter

Appendix B: Modbus Mapping for EPM 2200

B.1 Introduction

The Modbus Map for the EPM 2200 Meter gives details and information about the possible readings of the meter and about the programming of the meter.

The EPM 2200 can be programmed using the buttons on the face plate of the meter (6.1 *Programming Using the Faceplate*). The meter can also be programmed using software. For a Programming Overview, see section 6.4 *GE Communicator Programming Overview* of this manual. For further details see the *GE Communicator Instruction Manual*.

B.2 Modbus Register Map Sections

The EPM 2200 Modbus Register Map includes the following sections:

Fixed Data Section, Registers 1- 47, details the Meter's Fixed Information.

Meter Data Section, Registers 1000 - 5003, details the Meter's Readings, including Primary Readings, Energy Block, Demand Block, Maximum and Minimum Blocks, THD Block, Phase Angle Block and Status Block. Operating Mode readings are described in Section 6.1.13 *Operating Mode* on page 6–14.

Commands Section, Registers 20000 - 26011, details the Meter's Resets Block, Programming Block, Other Commands Block and Encryption Block.

Programmable Settings Section, Registers 30000 - 30067, details the Meter's Basic Setups.

Secondary Readings Section, Registers 40001 - 40100, details the Meter's Secondary Readings Setups.

B.3 Data Formats

ASCII: ASCII characters packed 2 per register in high, low order and without any termination characters.

Example: "EPM2200" would be 4 registers containing 0x5378, 0x6172, 0x6B31, 0x3030.

SINT16/UINT16:16-bit signed/unsigned integer.

SINT32/UINT32:32-bit signed/unsigned integer spanning 2 registers. The lower-addressed register is the high order half.

FLOAT:32-bit IEEE floating point number spanning 2 registers. The lower-addressed register is the high order half (i.e., contains the exponent).

B.4 Floating Point Values

Floating Point Values are represented in the following format:

Register	0																1															
Byte	0								1								0								1							
Bit	7	6	5	4	3	2	1	0	7	6	5	4	3	2	1	0	7	6	5	4	3	2	1	0	7	6	5	4	3	2	1	0
Meaning	s	e	e	e	e	e	e	e	e	m	m	m	m	m	m	m	m	m	m	m	m	m	m	m	m	m	m	m	m	m	m	m
	sign	exponent								mantissa																						

The formula to interpret a Floating Point Value is: $-1^{sign} \times 2^{exponent-127} \times 1.mantissa =$
 0x0C4E11DB9

$-1^{sign} \times 2^{137-127} \times 1.11000010001110111001$

$-1 \times 2^{10} \times 1.75871956$

-1800.929

Register	0x0C4E1																0x01DB9															
Byte	0x0C4								0x0E1								0x01D								0x0B9							
Bit	7	6	5	4	3	2	1	0	7	6	5	4	3	2	1	0	7	6	5	4	3	2	1	0	7	6	5	4	3	2	1	0
	1	1	0	0	0	1	0	0	1	1	1	0	0	0	0	1	0	0	0	1	1	1	0	1	1	1	0	1	1	1	0	1
Meaning	s	e	e	e	e	e	e	e	e	m	m	m	m	m	m	m	m	m	m	m	m	m	m	m	m	m	m	m	m	m	m	m
	sign	exponent								mantissa																						
	1	0x089 = 137								0b110000100011101110111001																						

Formula Explanation

C4E11DB9 (hex) 11000100 11100001 00011101 10111001 (binary)

The sign of the Mantissa (and therefore the number) is 1, which represents a negative value.

The Exponent is 10001001 (binary) or 137 decimal.

The Exponent is a value in excess of 127, so the Exponent value is 10.

The Mantissa is 11000010001110110111001 binary.

With the implied leading 1, the Mantissa is (1).C23B72 (hex).

The Floating Point Representation is therefore $-1.75871956 \times 2^{10}$

Decimal equivalent: -1800.929



Exponent = the whole number before the decimal point

Mantissa = the positive fraction after the decimal point

B.5 Modbus Register Map

Table B-1: Modbus Register Map (Sheet 1 of 7)

Hex	Decimal	Description ¹	Format	Range ⁶	Units or Resolution	Comments	# R e g
Fixed Data Section							
Identification Block							read-only
0000 - 0007	1 - 8	Meter Name	ASCII	16 char	none		8
0008 - 000F	9 - 16	Meter Serial Number	ASCII	16 char	none		8
0010 - 0010	17 - 17	Meter Type	UINT16	bit-mapped	-----t-----vvv	t = 0 vvv = Software Option A1, B1, or C1	1
0011 - 0012	18 - 19	Firmware Version	ASCII	4 char	none		2
0013 - 0013	20 - 20	Map Version	UINT16	0 to 65535	none		1
0014 - 0014	21 - 21	Meter Configuration	UINT16	bit-mapped	-----f-----	fffff = calibration frequency (50 or 60)	1
0015 - 0015	22 - 22	ASIC Version	UINT16	0-65535	none		1
0016 - 0026	23 - 39	Reserved					17
0027 - 002E	40 - 47	OEM Part Number					8
						Block Size:	47
Meter Data Section²							
Primary Readings Block, 6 cycles (IEEE Floating)							read-only
0383 - 0384	900 - 901	Watts, 3-Ph total	FLOAT	-9999 M to +9999 M	watts		2
0385 - 0386	902 - 903	VARs, 3-Ph total	FLOAT	-9999 M to +9999 M	VARs		2
0387 - 0388	904 - 905	VAs, 3-Ph total	FLOAT	-9999 M to +9999 M	VAs		2
						Block Size:	6
Primary Readings Block, 60 cycles (IEEE Floating Point)							read-only
03E7 - 03E8	1000 - 1001	Volts A-N	FLOAT	0 to 9999 M	volts		2
03E9 - 03EA	1002 - 1003	Volts B-N	FLOAT	0 to 9999 M	volts		2
03EB - 03EC	1004 - 1005	Volts C-N	FLOAT	0 to 9999 M	volts		2
03ED - 03EE	1006 - 1007	Volts A-B	FLOAT	0 to 9999 M	volts		2
03EF - 03F0	1008 - 1009	Volts B-C	FLOAT	0 to 9999 M	volts		2
03F1 - 03F2	1010 - 1011	Volts C-A	FLOAT	0 to 9999 M	volts		2
03F3 - 03F4	1012 - 1013	Amps A	FLOAT	0 to 9999 M	amps		2
03F5 - 03F6	1014 - 1015	Amps B	FLOAT	0 to 9999 M	amps		2

Table B-1: Modbus Register Map (Sheet 2 of 7)

Hex	Decimal	Description ¹	Format	Range ⁶	Units or Resolution	Comments	# Reg
03F7 - 03F8	1016 - 1017	Amps C	FLOAT	0 to 9999 M	amps		2
03F9 - 03FA	1018 - 1019	Watts, 3-Ph total	FLOAT	-9999 M to +9999 M	watts		2
03FB - 03FC	1020 - 1021	VARs, 3-Ph total	FLOAT	-9999 M to +9999 M	VARs		2
03FD - 03FE	1022 - 1023	VAs, 3-Ph total	FLOAT	-9999 M to +9999 M	VAs		2
03FF - 0400	1024 - 1025	Power Factor, 3-Ph total	FLOAT	-1.00 to +1.00	none		2
0401 - 0402	1026 - 1027	Frequency	FLOAT	0 to 65.00	Hz		2
0403 - 0404	1028 - 1029	Neutral Current	FLOAT	0 to 9999 M	amps		2
						Block Size:	30
Primary Energy Block							<i>read-only</i>
044B - 044C	1100 - 1101	W-hours, Received	SINT32	0 to 99999999 or 0 to -99999999	Wh per energy format	* Wh received & delivered always have opposite	2
044D - 044E	1102 - 1103	W-hours, Delivered	SINT32	0 to 99999999 or 0 to -99999999	Wh per energy format	* Wh received is positive for "view as load", delivered is positive for "view as generator"	2
044F - 0450	1104 - 1105	W-hours, Net	SINT32	-99999999 to 99999999	Wh per energy format		2
0451 - 0452	1106 - 1107	W-hours, Total	SINT32	0 to 99999999	Wh per energy format	* 5 to 8 digits	2
0453 - 0454	1108 - 1109	VAR-hours, Positive	SINT32	0 to 99999999	VARh per energy format	* decimal point implied, per energy format	2
0455 - 0456	1110 - 1111	VAR-hours, Negative	SINT32	0 to -99999999	VARh per energy format	* resolution of digit before decimal point = units, kilo, or mega, per energy format	2
0457 - 0458	1112 - 1113	VAR-hours, Net	SINT32	-99999999 to 99999999	VARh per energy format		2
0459 - 045A	1114 - 1115	VAR-hours, Total	SINT32	0 to 99999999	VARh per energy format		2
045B - 045C	1116 - 1117	VA-hours, Total	SINT32	0 to 99999999	VAh per energy format	* see note 10	2
						Block Size:	18
Primary Demand Block (IEEE Floating Point)							<i>read-only</i>
07CF - 07D0	2000 - 2001	Amps A, Average	FLOAT	0 to 9999 M	amps		2
07D1 - 07D2	2002 - 2003	Amps B, Average	FLOAT	0 to 9999 M	amps		2
07D3 - 07D4	2004 - 2005	Amps C, Average	FLOAT	0 to 9999 M	amps		2
07D5 - 07D6	2006 - 2007	Positive Watts, 3-Ph, Average	FLOAT	-9999 M to +9999 M	watts		2
07D7 - 07D8	2008 - 2009	Positive VARs, 3-Ph, Average	FLOAT	-9999 M to +9999 M	VARs		2
07D9 - 07DA	2010 - 2011	Negative Watts, 3-Ph, Average	FLOAT	-9999 M to +9999 M	watts		2
07DB - 07DC	2012 - 2013	Negative VARs, 3-Ph, Average	FLOAT	-9999 M to +9999 M	VARs		2
07DD - 07DE	2014 - 2015	VAs, 3-Ph, Average	FLOAT	-9999 M to +9999 M	VAs		2
07DF - 07E0	2016 - 2017	Positive PF, 3-Ph, Average	FLOAT	-1.00 to +1.00	none		2
07E1 - 07E2	2018 - 2019	Negative PF, 3-PF, Average	FLOAT	-1.00 to +1.00	none		2
						Block Size:	20
Primary Minimum Block (IEEE Floating Point)							<i>read-only</i>
0BB7 - 0BB8	3000 - 3001	Volts A-N, Minimum	FLOAT	0 to 9999 M	volts		2
0BB9 - 0BBA	3002 - 3003	Volts B-N, Minimum	FLOAT	0 to 9999 M	volts		2
0BBB - 0BBC	3004 - 3005	Volts C-N, Minimum	FLOAT	0 to 9999 M	volts		2
0BBD - 0BBE	3006 - 3007	Volts A-B, Minimum	FLOAT	0 to 9999 M	volts		2
0BBF - 0BC0	3008 - 3009	Volts B-C, Minimum	FLOAT	0 to 9999 M	volts		2
0BC1 - 0BC2	3010 - 3011	Volts C-A, Minimum	FLOAT	0 to 9999 M	volts		2

Table B-1: Modbus Register Map (Sheet 3 of 7)

Hex	Decimal	Description ¹	Format	Range ⁶	Units or Resolution	Comments	# Reg
0BC3 - 0BC4	3012 - 3013	Amps A, Minimum Avg Demand	FLOAT	0 to 9999 M	amps		2
0BC5 - 0BC6	3014 - 3015	Amps B, Minimum Avg Demand	FLOAT	0 to 9999 M	amps		2
0BC7 - 0BC8	3016 - 3017	Amps C, Minimum Avg Demand	FLOAT	0 to 9999 M	amps		2
0BC9 - 0BCA	3018 - 3019	Positive Watts, 3-Ph, Minimum Avg Demand	FLOAT	0 to +9999 M	watts		2
0BCB - 0BCC	3020 - 3021	Positive VARs, 3-Ph, Minimum Avg Demand	FLOAT	0 to +9999 M	VARs		2
0BCD - 0BCE	3022 - 3023	Negative Watts, 3-Ph, Minimum Avg Demand	FLOAT	0 to +9999 M	watts		2
0BCF - 0BD0	3024 - 3025	Negative VARs, 3-Ph, Minimum Avg Demand	FLOAT	0 to +9999 M	VARs		2
0BD1 - 0BD2	3026 - 3027	VAs, 3-Ph, Minimum Avg Demand	FLOAT	-9999 M to +9999 M	VAs		2
0BD3 - 0BD4	3028 - 3029	Positive Power Factor, 3-Ph, Minimum Avg Demand	FLOAT	-1.00 to +1.00	none		2
0BD5 - 0BD6	3030 - 3031	Negative Power Factor, 3-Ph, Minimum Avg Demand	FLOAT	-1.00 to +1.00	none		2
0BD7 - 0BD8	3032 - 3033	Frequency, Minimum	FLOAT	0 to 65.00	Hz		2
						Block Size:	34
Primary Maximum Block (IEEE Floating Point)							read-only
0C1B - 0C1C	3100 - 3101	Volts A-N, Maximum	FLOAT	0 to 9999 M	volts		2
0C1D - 0C1E	3102 - 3103	Volts B-N, Maximum	FLOAT	0 to 9999 M	volts		2
0C1F - 0C20	3104 - 3105	Volts C-N, Maximum	FLOAT	0 to 9999 M	volts		2
0C21 - 0C22	3106 - 3107	Volts A-B, Maximum	FLOAT	0 to 9999 M	volts		2
0C23 - 0C24	3108 - 3109	Volts B-C, Maximum	FLOAT	0 to 9999 M	volts		2
0C25 - 0C26	3110 - 3111	Volts C-A, Maximum	FLOAT	0 to 9999 M	volts		2
0C27 - 0C28	3112 - 3113	Amps A, Maximum Avg Demand	FLOAT	0 to 9999 M	amps		2
0C29 - 0C2A	3114 - 3115	Amps B, Maximum Avg Demand	FLOAT	0 to 9999 M	amps		2
0C2B - 0C2C	3116 - 3117	Amps C, Maximum Avg Demand	FLOAT	0 to 9999 M	amps		2
0C2D - 0C2E	3118 - 3119	Positive Watts, 3-Ph, Maximum Avg Demand	FLOAT	0 to +9999 M	watts		2
0C2F - 0C30	3120 - 3121	Positive VARs, 3-Ph, Maximum Avg Demand	FLOAT	0 to +9999 M	VARs		2
0C31 - 0C32	3122 - 3123	Negative Watts, 3-Ph, Maximum Avg Demand	FLOAT	0 to +9999 M	watts		2
0C33 - 0C34	3124 - 3125	Negative VARs, 3-Ph, Maximum Avg Demand	FLOAT	0 to +9999 M	VARs		2
0C35 - 0C36	3126 - 3127	VAs, 3-Ph, Maximum Avg Demand	FLOAT	-9999 M to +9999 M	VAs		2
0C37 - 0C38	3128 - 3129	Positive Power Factor, 3-Ph, Maximum Avg Demand	FLOAT	-1.00 to +1.00	none		2
0C39 - 0C3A	3130 - 3131	Negative Power Factor, 3-Ph, Maximum Avg Demand	FLOAT	-1.00 to +1.00	none		2
0C3B - 0C3C	3132 - 3133	Frequency, Maximum	FLOAT	0 to 65.00	Hz		2
						Block Size:	34

Table B-1: Modbus Register Map (Sheet 4 of 7)

Hex	Decimal	Description ¹	Format	Range ⁶	Units or Resolution	Comments	# Reg
Phase Angle Block¹⁴							read-only
1003 - 1003	4100 - 4100	Phase A Current	SINT16	-1800 to +1800	0.1 degree		1
1004 - 1004	4101 - 4101	Phase B Current	SINT16	-1800 to +1800	0.1 degree		1
1005 - 1005	4102 - 4102	Phase C Current	SINT16	-1800 to +1800	0.1 degree		1
1006 - 1006	4103 - 4103	Angle, Volts A-B	SINT16	-1800 to +1800	0.1 degree		1
1007 - 1007	4104 - 4104	Angle, Volts B-C	SINT16	-1800 to +1800	0.1 degree		1
1008 - 1008	4105 - 4105	Angle, Volts C-A	SINT16	-1800 to +1800	0.1 degree		1
						Block Size:	6
Status Block							read-only
1387 - 1387	5000 - 5000	Meter Status	UINT16	bit-mapped	--expnch ssssssss	expnch = EEPROM block OK flags (e=energy, x=max, n=min, p=programmable settings, c=calibration, h=header), ssssssss = state (1=Run, 2=Limp, 10=Prog Set Update via buttons, 12=Prog Set Update via communication port.)	1
1388 - 1388	5001 - 5001	Not Used	N/A				
1389 - 138A	5002 - 5003	Time Since Reset	UINT32	0 to 4294967294	4 msec	wraps around after max count	2
						Block Size:	4
Commands Section⁴							
Resets Block⁹							write-only
4E1F - 4E1F	20000 - 20000	Reset Max/Min Blocks	UINT16	password ⁵			1
4E20 - 4E20	20001 - 20001	Reset Energy Accumulators	UINT16	password ⁵			1
						Block Size:	2
Meter Programming Block							read/conditional write
55EF - 55EF	22000 - 22000	Initiate Programmable Settings Update	UINT16	password ⁵		meter enters PS update mode	1
55F0 - 55F0	22001 - 22001	Terminate Programmable Settings Update ³	UINT16	any value		meter leaves PS update mode via reset	1
55F1 - 55F1	22002 - 22002	Calculate Programmable Settings Checksum ³	UINT16			meter calculates checksum on RAM copy of PS block	1
55F2 - 55F2	22003 - 22003	Programmable Settings Checksum ³	UINT16			read/write checksum register; PS block saved in EEPROM on write ⁸	1
55F3 - 55F3	22004 - 22004	Write New Password ³	UINT16	0000 to 9999		write-only register; always reads zero	1
59D7 - 59D7	23000 - 23000	Initiate Meter Firmware Reprogramming	UINT16	password ⁵			1
						Block Size:	6
Other Commands Block							read/write
61A7 - 61A7	25000 - 25000	Force Meter Restart	UINT16	password ⁵		causes a watchdog reset, always reads 0	1
						Block Size:	1

Table B-1: Modbus Register Map (Sheet 5 of 7)

Hex	Decimal	Description ¹	Format	Range ⁶	Units or Resolution	Comments	# Reg
Encryption Block							
							read/write
658F - 659A	26000 - 26011	Perform a Secure Operation	UINT16			encrypted command to read password or change meter type	12
						Block Size:	12
Programmable Settings Section (See note 15)							
Basic Setups Block							write only in PS update mode
752F - 752F	30000 - 30000	CT multiplier & denominator	UINT16	bit-mapped	dddddddd mmmmmmmm	high byte is denominator (5, read-only), low byte is multiplier (1, 10, or 100)	1
7530 - 7530	30001 - 30001	CT numerator	UINT16	1 to 9999	none		1
7531 - 7531	30002 - 30002	PT numerator	UINT16	1 to 9999	none		1
7532 - 7532	30003 - 30003	PT denominator	UINT16	1 to 9999	none		1
7533 - 7533	30004 - 30004	PT multiplier & hookup	UINT16	bit-mapped	mmmmmmmm MMMMhhhh	MMMMmmmmmmmm is PT multiplier (1, 10, 100, 1000), hhhh is hookup enumeration (0 = 3 element wye[9S], 1 = delta 2 CTs[5S], 3 = 2.5 element	1
7534 - 7534	30005 - 30005	Averaging Method	UINT16	bit-mapped	--iiiiii b----sss	iiiiii = interval (5,15,30,60) b = 0=block or 1=rolling sss = # subintervals (1,2,3,4)	1
7535 - 7535	30006 - 30006	Power & Energy Format	UINT16	bit-mapped	pppp--nn -eee- ddd	pppp = power scale (0-unit, 3-kilo, 6-mega, 8-auto) nn = number of energy digits (5-8 --> 0-3) eee = energy scale (0-unit, 3-kilo, 6-mega) ddd = energy digits after decimal point (0-6) See note 10.	1
7536 - 7536	30007 - 30007	Operating Mode Screen Enables	UINT16	bit-mapped	00000000 eeeeeeee	eeeeeeee = op mode screen rows on(1) or off(0), rows top to bottom are bits low order to high order	1
7537 - 753D	30008 - 30014	Reserved					7
753E - 753E	30015 - 30015	User Settings Flags	UINT16	bit-mapped	---g--nn srp--wf-	g = enable alternate full scale bargraph current (1=on, 0=off) nn = number of phases for voltage & current screens (3=ABC, 2=AB, 1=A, 0=ABC) s = scroll (1=on, 0=off) r = password for reset in use (1=on, 0=off) p = password for configuration in use (1=on, 0=off) w = pwr dir (0-view as load, 1-view as generator) f = flip power factor sign (1=yes, 0=no)	1

Table B-1: Modbus Register Map (Sheet 6 of 7)

Hex	Decimal	Description ¹	Format	Range ⁶	Units or Resolution	Comments	# Reg
753F - 753F	30016 - 30016	Full Scale Current (for load % bargraph)	UINT16	0 to 9999	none	If non-zero and user settings bit g is set, this value replaces CT numerator in the full scale current calculation.	1
7540 - 7547	30017 - 30024	Meter Designation	ASCII	16 char	none		8
7548 - 7548	30025 - 30025	Not Used					1
7549 - 7549	30026 - 30026	COM2 setup	UINT16	bit-mapped	----dddd -ppp- bbb	dddd = reply delay (* 50 msec) ppp = protocol (1-Modbus RTU, 2-Modbus ASCII) bbb = baud rate (1-9600, 2-19200, 4-38400, 6-57600)	1
754A - 754A	30027 - 30027	COM2 address	UINT16	1 to 247	none		1
754B - 754B	30028 - 30028	Not Used	N/A				1
754C - 754C	30029 - 30029	Not Used	N/A				1
754D - 754D	30030 - 30030	Not Used	N/A				1
754E - 754E	30031 - 30031	Not Used	N/A				1
754F - 754F	30032 - 30032	Not Used	N/A				1
7550 - 7554	30033 - 30037	Not Used	N/A				5
7555 - 7559	30038 - 30042	Not Used	N/A				5
755A - 755E	30043 - 30047	Not Used	N/A				5
755F - 7563	30048 - 30052	Not Used	N/A				5
7564 - 7568	30053 - 30057	Not Used	N/A				5
7569 - 756D	30058 - 30062	Not Used	N/A				5
756E - 7572	30063 - 30067	Not Used	N/A				5
						Block Size:	68
Secondary Readings Section							
12-Bit Block						read-only except as noted	
9C40 - 9C40	40001 - 40001	System Sanity Indicator	UINT16	0 or 1	none	0 indicates proper meter operation	1
9C41 - 9C41	40002 - 40002	Volts A-N	UINT16	2047 to 4095	volts	2047= 0, 4095= +150	1
9C42 - 9C42	40003 - 40003	Volts B-N	UINT16	2047 to 4095	volts	volts = 150 * (register - 2047) / 2047	1
9C43 - 9C43	40004 - 40004	Volts C-N	UINT16	2047 to 4095	volts		1
9C44 - 9C44	40005 - 40005	Amps A	UINT16	0 to 4095	amps	0= -10, 2047= 0, 4095= +10	1
9C45 - 9C45	40006 - 40006	Amps B	UINT16	0 to 4095	amps	amps = 10 * (register - 2047) / 2047	1
9C46 - 9C46	40007 - 40007	Amps C	UINT16	0 to 4095	amps		1

Table B-1: Modbus Register Map (Sheet 7 of 7)

Hex	Decimal	Description ¹	Format	Range ⁶	Units or Resolution	Comments	# Register
9C47 - 9C47	40008 - 40008	Watts, 3-Ph total	UINT16	0 to 4095	watts	0= -3000, 2047= 0, 4095= +3000	1
9C48 - 9C48	40009 - 40009	VARs, 3-Ph total	UINT16	0 to 4095	VARs	watts, VARs, VAs =	1
9C49 - 9C49	40010 - 40010	VAs, 3-Ph total	UINT16	2047 to 4095	VAs	3000 * (register - 2047) /	1
9C4A - 9C4A	40011 - 40011	Power Factor, 3-Ph total	UINT16	1047 to 3047	none	1047= -1, 2047= 0, 3047= +1 pf = (register - 2047) / 1000	1
9C4B - 9C4B	40012 - 40012	Frequency	UINT16	0 to 2730	Hz	0= 45 or less, 2047= 60, 2730=65 or more freq = 45 + ((register / 4095) * 30)	1
9C4C - 9C4C	40013 - 40013	Volts A-B	UINT16	2047 to 4095	volts	2047= 0, 4095= +300	1
9C4D - 9C4D	40014 - 40014	Volts B-C	UINT16	2047 to 4095	volts	volts = 300 * (register - 2047) / 2047	1
9C4E - 9C4E	40015 - 40015	Volts C-A	UINT16	2047 to 4095	volts		1
9C4F - 9C4F	40016 - 40016	CT numerator	UINT16	1 to 9999	none	CT = numerator * multiplier / denominator	1
9C50 - 9C50	40017 - 40017	CT multiplier	UINT16	1, 10, 100	none		1
9C51 - 9C51	40018 - 40018	CT denominator	UINT16	1 or 5	none		1
9C52 - 9C52	40019 - 40019	PT numerator	UINT16	1 to 9999	none	PT = numerator * multiplier / denominator	1
9C53 - 9C53	40020 - 40020	PT multiplier	UINT16	1, 10, 100	none		1
9C54 - 9C54	40021 - 40021	PT denominator	UINT16	1 to 9999	none		1
9C55 - 9C56	40022 - 40023	W-hours, Positive	UINT32	0 to 99999999	Wh per energy format	* 5 to 8 digits	2
9C57 - 9C58	40024 - 40025	W-hours, Negative	UINT32	0 to 99999999	Wh per energy format	* decimal point implied, per energy format	2
9C59 - 9C5A	40026 - 40027	VAR-hours, Positive	UINT32	0 to 99999999	VARh per energy format	* resolution of digit before decimal point = units, kilo, or mega, per energy format	2
9C5B - 9C5C	40028 - 40029	VAR-hours, Negative	UINT32	0 to 99999999	VARh per energy format		2
9C5D - 9C5E	40030 - 40031	VA-hours	UINT32	0 to 99999999	VAh per energy format	* see note 10	2
9C5F - 9C5F	40032 - 40032	Neutral Current	UINT16	0 to 4095	amps	see Amps A/B/C above	1
9C60 - 9CA2	40033 - 40099	Reserved	N/A	N/A	none		67
9CA3 - 9CA3	40100 - 40100	Reset Energy Accumulators	UINT16	password ⁵		write-only register; always reads as 0	1
						Block Size:	100

- ASCII ASCII characters packed 2 per register in high, low order and without any termination characters. For example, "EPM2200" would be 4 registers containing 0x5378, 0x6172, 0x6B31, 0x3030.
 - SINT16/UINT16 16-bit signed / unsigned integer.
 - SINT32/UINT32 32-bit signed / unsigned integer spanning 2 registers. The lower-addressed register is the high order half.
 - FLOAT 32-bit IEEE floating point number spanning 2 registers. The lower-addressed register is the high order half (i.e., contains the exponent).
- 1 All registers not explicitly listed in the table read as 0. Writes to these registers will be accepted but won't actually change the register (since it doesn't exist).
- 2 Meter Data Section items read as 0 until first readings are available or if the meter is not in operating mode. Writes to these registers will be accepted but won't actually change the register.

3	Register valid only in programmable settings update mode. In other modes these registers read as 0 and return an illegal data address exception if a write is attempted..
4	Meter command registers always read as 0. They may be written only when the meter is in a suitable mode. The registers return an illegal data address exception if a write is attempted in an incorrect mode.
5	If the password is incorrect, a valid response is returned but the command is not executed. Use 5555 for the password if passwords are disabled in the programmable settings.
6	M denotes a 1,000,000 multiplier.
7	Not applicable to EPM 2200
8	Writing this register causes data to be saved permanently in EEPROM. If there is an error while saving, a slave device failure exception is returned and programmable settings mode automatically terminates via reset.
9	Reset commands make no sense if the meter state is LIMP. An illegal function exception will be returned.
10	Energy registers should be reset after a format change.
11	N/A
13	N/A
14	All 3 voltage angles are measured for Wye and Delta hookups. For 2.5 Element, Vac is measured and Vab & Vbc are calculated. If a voltage phase is missing, the two voltage angles in which it participates are set to zero. A and C phase current angles are measured for all hookups. B phase current angle is measured for Wye and is zero for other hookups. If a voltage phase is missing, its current angle is zero.
15	If any register in the programmable settings section is set to a value other than the acceptable value then the meter will stay in LIMP mode. Please read the comments section or the range for each register in programmable settings section for acceptable settings.
16	N/A

EPM 2200 Power Meter

Appendix C: Manual Revision History

C.1 Release Notes

Table C-1: Release Dates

MANUAL	GE PART NO.	RELEASE DATE
GEK-113575	1601-9111-A1	March 2011
GEK-113575A	1601-9111-A2	April 2011
GEK-113575B	1601-9111-A3	August 2015
GEK-113575C	1601-9111-A4	November 2015
GEK-113575D	1601-9111-A5	June 2016

Table C-2: Major Updates for 1601-9111-A5

SECT (A4)	SECT (A5)	DESCRIPTION
Title	Title	Manual part number to 1601-9111-A5. Rebranded to Grid Solutions.
2.1	2.1	UL disclaimer added.
2.3	2.3	Updated Compliance table
7.2	7.2	Updated number of BACnet objects to 56 Updated BACnet object table
7.4.1	7.4.1	Updated BACnet .csv example

Table C-3: Major Updates for 1601-9111-A4

SECT (A3)	SECT (A4)	DESCRIPTION
Title	Title	Manual part number to 1601-9111-A4.
1.2	1.2	Figure 1.2 updated
2.1.1	2.1.1	Section reworded for clarity.
N/A	N/A	Minor corrections throughout.

Table C-4: Major Updates for 1601-9111-A3

SECT (A2)	SECT (A3)	DESCRIPTION
Title	Title	Manual part number to 1601-9111-A3.
2.3	2.3	Updated Compliance section.
4.2	4.2	Updated electrical wiring diagrams.
N/A	Ch7	Added communications option B (BACnet) Ch7 and throughout.
N/A	N/A	Re-organized information, updated formats, and made corrections throughout.